

### Why Choose EBS Automatic Slack Adjusters:

- Comprehensive Range with ex-stock availability.
- Competitive pricing.
- All EBS Slack Adjusters will directly replace numerous other brands.
- Greater interchangeability gives the ability to stock fewer part numbers.
- Higher versatility - less limitation on the control arm installation angle.
- Cost saving - EBS offers an “Intelligent Automatic Slack Adjuster” with the control arm automatically finding the initial position, reducing set up times.

### Testing:

- Durability Testing.
- Torsional Fatigue Strength Testing.
- Waterproof Testing.

### Conformity:

- ISO/TS16949:2009.
- ISO/9001-2008.
- First purpose built testing facility of it's kind.
- New application patent certificates.
- Invention certificate for Automatic Adjusting Device.



High quality brass bushes.

All EBS Automatic Slack Adjusters are fitted with grease nipples.

Fully branded.

EBS Part Reference for ease of identification and traceability.

High quality strengthened cover plate and fixing screws.

Intelligent Control Arm\*  
- Automatically finds its initial position.

\*Only on the Self Adjusting Versions

# TRUCK & BUS FITMENT POSITION GUIDE

FOR TRAILER APPLICATIONS - SEE PAGES 25.30 TO 25.36

Where possible EBS has detailed to which side of the vehicle the EBS slack adjuster reference is fitted.

The information we have provided within this section should only be used as a guide. The guaranteed way of selecting the correct replacement EBS product is to identify the actual reference of the item that is being removed from the vehicle itself.

Please note - as the information is not always available this is only an indication of the applications suited for each EBS reference.













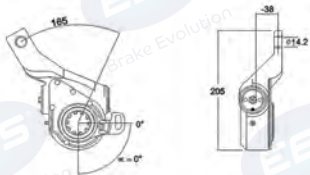

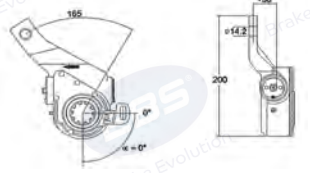

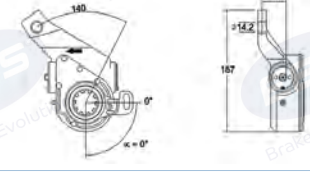

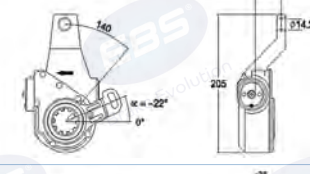
1 = Right Hand Side Of Vehicle Fitment

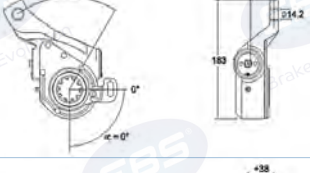
2 = Left Hand Side Of Vehicle Fitment

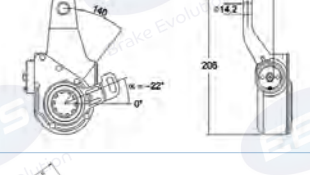
## EBS AUTOMATIC SLACK ADJUSTERS - TRUCK & BUS - DAF

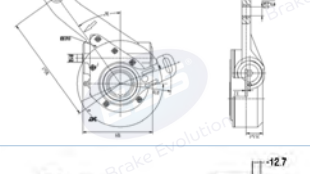
EBS Part No.	Application	Fitment Position (Chart - P25.4)	Spline Teeth No	Alternative	Opposite Hand	Image		
EBS2010	DAF TRUCK OE: 0159556	2	10	4W2010	EBS2015			
		Left		KB2010				
				72523				
EBS2015	DAF TRUCK OE: 0159557	1	10	4W2015	EBS2010			
		Right		KB2015				
				72524				
EBS2020	DAF TRUCK OE: 0159589	1	10	4W2020	EBS2025			
		Right		KB2020				
				72538				
EBS2025	DAF TRUCK OE: 0159590	2	10	4W2025	EBS2020			
		Left		KB2025				
				72539				
EBS2030	DAF TRUCK & BUS OE: 0537538	1 & 2	10	4W2030	N/A			
		Right & Left		KB2030				
				72534				

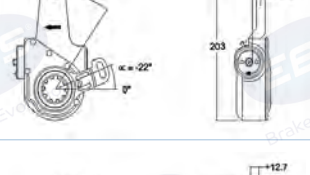
**EBS AUTOMATIC SLACK ADJUSTERS - TRUCK & BUS - DAF**

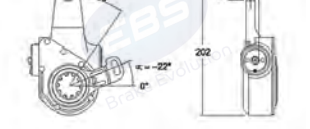









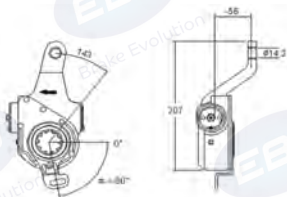

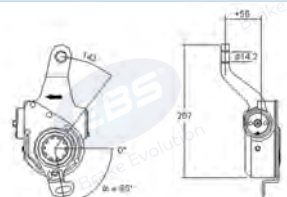

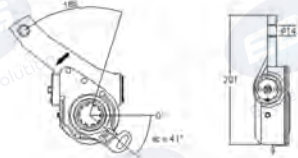
EBS Part No.	Application	Fitment Position (Chart - P25.4)	Spline Teeth No	Alternative	Opposite Hand	Image	
EBS2035	DAF TRUCK OE: 0159562	1 Right	10	4W2035	EBS2105		
				KB2035			
				72543			
EBS2105	DAF TRUCK OE: 0159561	2 Left	10	4W2105	EBS2035		
				KB2105			
				72542			
EBS2110	DAF TRUCK & BUS OE: 0159587	2 Left	10	4W2110	EBS2120		
				KB2110			
				72536			
EBS2115	DAF TRUCK & BUS OE: 0159558	2 Left	10	4W2115	EBS2125		
				KB2115			
				72525			
EBS2120	DAF TRUCK & BUS OE: 0159588	1 Right	10	4W2120	EBS2110		
				KB2120			
				72537			
EBS2125	DAF TRUCK & BUS OE: 0159559	1 Right	10	4W2125	EBS2115		
				KB2125			
				72526			
EBS2305	DAF TRUCK OE: 0159591	1+2 Right + Left	10	4W2305	N/A		
				KB2305			
				72540C			
EBS2400	DAF TRUCK & BUS OE: 0740321	2 Left	10	4W2400	EBS2425		
				KB2400			
				72608			
EBS2425	DAF TRUCK & BUS OE: 0740322	1 Right	10	4W2425	EBS2400		
				KB2425			
				72609			

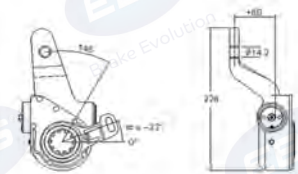
SLACK ADJUSTERS

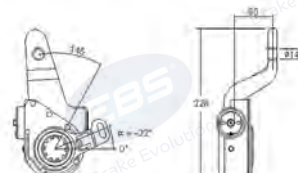
**EBS AUTOMATIC SLACK ADJUSTERS - TRUCK & BUS - DAF**

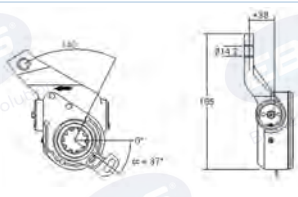
EBS Part No.	Application	Fitment Position (Chart - P25.4)	Spline Teeth No	Alternative	Opposite Hand	Image	
EBS2515	DAF BUS OE: 0159565	1 & 2	10	4W2515	N/A		
		Right & Left		KB2515			
				72535			
EBS2725	DAF TRUCK OE: 1263485	2	10	4W2725	EBS2730		
		Left		KB2725			
				72886			
EBS2730	DAF TRUCK OE: 1263486	1	10	4W2730	EBS2725		
		Right		KB2730			
				72887			
EBS2760	DAF TRUCK OE: 159560	1 & 2	10	4W2760	N/A		
		Right & Left		KB2760			
				72530C			
EBS2816	DAF BUS OE: N/A	2	10	4W3000	EBS3005		
		Left		KB3000			
				72816			
EBS3005	DAF BUS OE: N/A	1	10	4W3005	EBS2816		
		Right		KB3005			
				72815			
EBS3425	DAF TRUCK OE: 1282111	2	10	4W3425	EBS3430		
		Left		KB3425			
				79024			
EBS3430	DAF TRUCK OE: 1282112	1	10	4W3430	EBS3425		
		Right		KB3430			
				73025			

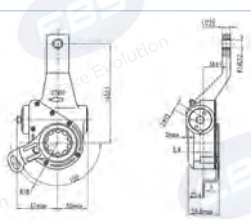
**EBS AUTOMATIC SLACK ADJUSTERS - TRUCK & BUS - DAF**

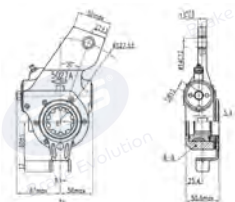
EBS Part No.	Application	Fitment Position (Chart - P25.4)	Spline Teeth No	Alternative	Opposite Hand	Image	
EBS3655	DAF TRUCK OE: 0159563	2	10	4W3655	EBS3660		
		Left		KB3655			
		72544					
EBS3660	DAF TRUCK OE: 0159564	1	10	4W3660	EBS3655		
		Right		KB3660			
		72545					
EBS3665	DAF TRUCK OE: 0159576	1 & 2	10	4W3665	N/A		
		Right & Left		KB3665			
		72547					
EBS3700	DAF TRUCK OE: 0755616	2	10	4W3700	EBS3705		
		Left		KB3700			
				72704			
EBS3705	DAF TRUCK OE: 0755617	1	10	4W3705	EBS3700		
		Right		KB3705			
				72705			
EBS3790	DAF BUS OE: 0097774	1	10	4W3790	N/A		
		Right		KB3790			
				72679			
EBS4305	DAF OE: 292924	---	10	4W4305	---		
		---		---			
		---		72532			
25.80.0133	DAF OE: 1511183	---	10	80133C	N/A		
		---		6Y6600			

SLACK ADJUSTERS

**EBS AUTOMATIC SLACK ADJUSTERS - TRUCK & BUS - FODEN**



EBS Part No.	Application	Fitment Position (Chart - P25.4)	Spline Teeth No	Alternative	Opposite Hand	Image	
EBS2170	FODEN TRUCK OE: 2700021000	1 & 2	28	4W2170	N/A		
		Right & Left		KB2170			
				72181			
EBS2235	FODEN TRUCK OE: 2700020000	1 & 2	28	4W2235	N/A		
		Right & Left		KB2235			
				72180			
EBS3300	FODEN TRUCK OE: 2700040000	1 & 2	28	4W3300	N/A		
		Right & Left		KB3300			
				72939			
EBS3460	FODEN TRUCK OE: N/A	1 & 2	10	4W3460	N/A		
		Right & Left		KB3460			
				72568C			
EBS4135	FODEN TRUCK OE: N/A	1 & 2	10	4W4135	N/A		
		Right & Left		79133C			
				---			
EBS4215	FODEN TRUCK OE: N/A	1	28	4W4215	N/A		
		Right & Left		KB4215			
				79682			



**EBS AUTOMATIC SLACK ADJUSTERS - TRUCK & BUS - HINO**

EBS Part No.	Application	Fitment Position (Chart - P25.4)	Spline Teeth No	Alternative	Opposite Hand	Image	
EBS2405	HINO TRUCK OE: 474801790	1	19	4W2405	EBS2410		
		Front Right		KB2405			
		12254					
EBS2410	HINO TRUCK OE: 474901180	2	19	4W2410	EBS2405		
		Front Left		KB2410			
		12255					
EBS2415	HINO TRUCK OE: 474801801	1 & 2	19	4W2415	N/A		
		Rear Right & Left		KB2415			
		12256					

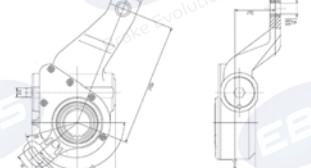
**EBS AUTOMATIC SLACK ADJUSTERS - TRUCK & BUS - IVECO**

EBS Part No.	Application	Fitment Position (Chart - P25.4)	Spline Teeth No	Alternative	Opposite Hand	Image	
EBS2745	IVECO TRUCK OE: 4692759	1 & 2	8	4W2745	N/A		
		Right & Left		KB2745			
		78010					
EBS3495	IVECO BUS OE: 0178529	1 & 2	10	4W3495	N/A		
		Right & Left		KB3495			
		70903C					
EBS3645	IVECO BUS OE: 3231273	1	19	4W3645	EBS3650		
		Right		KB3645			
		72929C					
EBS3650	IVECO BUS	2	19	---	EBS3645		
		Left		---			
		72930C					

SLACK ADJUSTERS









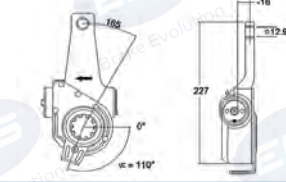

**EBS AUTOMATIC SLACK ADJUSTERS - TRUCK & BUS - KASSBOHRER**

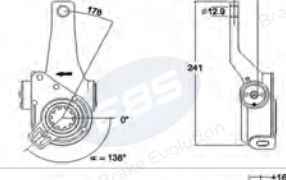
EBS Part No.	Application	Fitment Position (Chart - P25.4)	Spline Teeth No	Alternative	Opposite Hand	Image	
EBS2085	KASSBOHRER BUS OE: 8238000835	1 & 2 Right & Left	37	4W2085	N/A		
				KB2085			
				72758C			
EBS2975	KASSBOHRER BUS OE: 82850002140	2 Left	19	4W2975	EBS3575		
				KB2975			
				72592C			
EBS3255	KASSBOHRER BUS OE: 82830005520	2 Left	19	4W3255	EBS3260		
				KB3255			
				72014			
EBS3260	KASSBOHRER BUS OE: 82830005530	1 Right	19	4W3260	EBS3255		
				KB3260			
				72015			
EBS3575	KASSBOHRER BUS OE: 82850002130	1 Right	19	4W3575	EBS2975		
				KB3575			
				72591C			
EBS3680	KASSBOHRER BUS OE: 82850000900	2 Left	19	4W3680	EBS3685		
				KB3680			
				79040C			
EBS3685	KASSBOHRER BUS OE: 82850000890	1 Right	19	4W3685	EBS3680		
				KB3685			
				79041C			

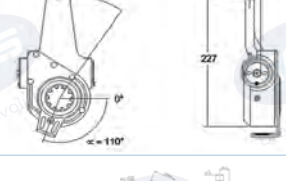
**EBS AUTOMATIC SLACK ADJUSTERS - TRUCK & BUS - LIAZ**

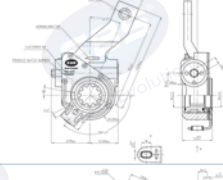
EBS Part No.	Application	Fitment Position (Chart - P25.4)	Spline Teeth No	Alternative	Opposite Hand	Image	
EBS3900	LIAZ BUS OE: N/A	1 & 2 Right & Left	20	4W3900	N/A		
				KB3900			
				---			

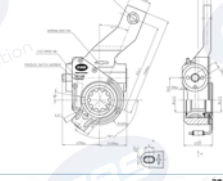
**EBS AUTOMATIC SLACK ADJUSTERS - TRUCK & BUS - LEYLAND**

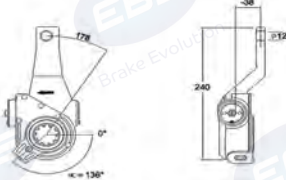
EBS Part No.	Application	Fitment Position (Chart - P25.4)	Spline Teeth No	Alternative	Opposite Hand	Image	
EBS2355	LEYLAND BUS OE: 10901199	1 Right	10	4W2355	EBS2390		
				KB2355			
				70583C			
EBS2365	LEYLAND BUS OE: 10907246	1 Right	10	4W2365	EBS2655		
				KB2365			
				70512			
EBS2390	LEYLAND BUS OE: 10901200	2 Left	10	4W2390	EBS2355		
				KB2390			
				70582C			
EBS2475	LEYLAND BUS OE: ACU3627	2 Left	10	4W2475	EBS2480		
				70943C			
EBS2480	LEYLAND BUS OE: ACU3628	1 Right	10	4W2480	EBS2475		
				70944C			
EBS2655	LEYLAND BUS OE: 10907245	2 Left	10	4W2655	EBS2365		
				KB2655			
				70511			











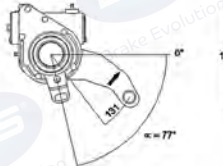
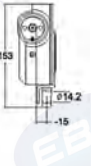

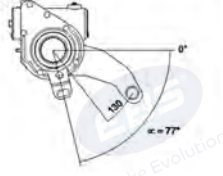
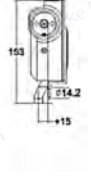

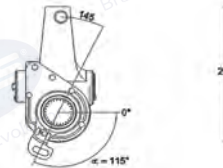

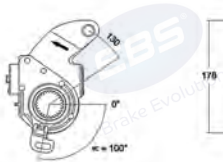

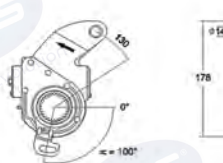
SLACK ADJUSTERS

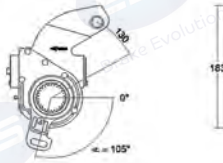

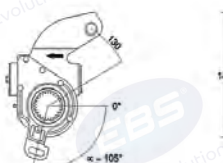
**EBS AUTOMATIC SLACK ADJUSTERS - TRUCK & BUS - MAN**

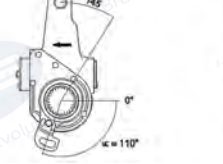
EBS Part No.	Application	Fitment Position (Chart - P25.4)	Spline Teeth No	Alternative	Opposite Hand	Image		
EBS2070	MAN TRUCK OE: 81506106211	2  Left	26	4W2070	EBS2075			
				KB2070				
				79208				
EBS2075	MAN TRUCK OE: 81506106210	1  Right	26	4W2075	EBS2070			
				KB2075				
				79209				
EBS2080	MAN TRUCK & BUS OE: 81506106231	1 & 2  Right & Left	26	4W2080	N/A			
				KB2080				
				79212				
EBS2090	MAN TRUCK OE: 81506106212	1  Right	26	4W2090	EBS2095			
				KB2090				
				79211				
EBS2095	MAN TRUCK OE: 81506106213	2  Left	26	4W2095	EBS2090			
				KB2095				
				79210				
EBS2610	MAN TRUCK OE: 81506106214	2  Left	26	4W2610	EBS2615			
				KB2610				
				79205				
EBS2615	MAN TRUCK OE: 81506106215	1  Right	26	4W2615	EBS2610			
				KB2615				
				79206				
EBS2620	MAN TRUCK & BUS OE: 81506106220	1  Right	26	4W2620	EBS2625			
				KB2620				
				79223				
EBS2625	MAN TRUCK & BUS OE: 81506106221	2  Left	26	4W2625	EBS2620			
				KB2625				
				79224				

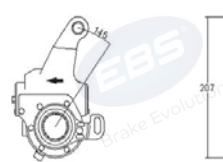
**EBS AUTOMATIC SLACK ADJUSTERS - TRUCK & BUS - MAN**

EBS Part No.	Application	Fitment Position (Chart - P25.4)	Spline Teeth No	Alternative	Opposite Hand	Image		
EBS3115	MAN BUS OE: 81506106222	2  Left	26	4W3115	EBS3120			
				KB3115				
				79225				
EBS3120	MAN BUS OE: 81506106223	1  Right	26	4W3120	EBS3115			
				KB3120				
				79226				
EBS3165	MAN TRUCK OE: 81506106216	1 & 2  Right & Left	26	4W3165	N/A			
				KB3165				
				79227				
EBS3265	MAN BUS OE: 81506106206	2  Left	26	4W3265	EBS3270			
				KB3265				
				79216C				
EBS3270	MAN BUS OE: 81506106205	1  Right	26	4W3270	EBS3265			
				KB3270				
				72979				
EBS3335	MAN BUS OE: 81506106203	2  Left	26	4W3335	EBS3340			
				KB3335				
				79220				
EBS3340	MAN BUS OE: 81506106204	1  Right	26	4W3340	EBS3335			
				KB3340				
				79219				
EBS3400	MAN TRUCK & BUS OE: 81506106217	1 & 2  Right & Left	26	4W3400	N/A			
				KB3400				
				79207C 72967				
25.80.0086	MAN TGA OE: 81506106266  Self-setting Automatic Slack Adjuster	---  ---	26	6Y6625	---			
				KB6625				
				80183				

SLACK ADJUSTERS

**EBS AUTOMATIC SLACK ADJUSTERS - TRUCK & BUS - MAN**

EBS Part No.	Application	Fitment Position (Chart - P23.4)	Spline Teeth No	Alternative	Opposite Hand	Image	
25.80.0176	MAN TGA OE: 81506106263 Self-setting Automatic Slack Adjuster	2 Left	26	6Y6620	25.80.0177		
				KB6620			
				80176			
25.80.0177	MAN OE: 81506106256 Self-setting Automatic Slack Adjuster	1 Right	26	6Y6720	25.80.0176		
				---			
				80177			
25.80.0178	MAN OE: 81506106259 Self-setting Automatic Slack Adjuster	2 Left	26	6Y6725	25.80.0179		
				---			
				80178			
25.80.0179	MAN OE: 81506106260 Self-setting Automatic Slack Adjuster	1 Right	26	6Y6730	25.80.0178		
				---			
				80179			
25.80.0180	MAN TGA OE: 81506106261 Self-setting Automatic Slack Adjuster	2 Left	26	6Y6630	25.80.0181		
				KB6630			
				80180			
25.80.0181	MAN TGA OE: 81506106262 Self-setting Automatic Slack Adjuster	1 Right	26	6Y6660	25.80.0180		
				KB6660			
				80181			

**EBS AUTOMATIC SLACK ADJUSTERS - TRUCK & BUS - MCW**

EBS Part No.	Application	Fitment Position (Chart - P23.4)	Spline Teeth No	Alternative	Opposite Hand	Image	
EBS2310	MCW BUS OE: 8226963	2 Left	10	4W2310	EBS2700		
				KB2310			
				70893			
EBS2700	MCW BUS OE: 8226964	1 Right	10	4W2700	EBS2310		
				KB2700			
				70894			
EBS3170	MCW BUS OE: 2210966	2 Left	10	4W3170	---		
				KB3170			
				70931			

**EBS AUTOMATIC SLACK ADJUSTERS - TRUCK & BUS - MERCEDES**

EBS Part No.	Application	Fitment Position (Chart - P25.4)	Spline Teeth No	Alternative	Opposite Hand	Image		
EBS2040	MERCEDES BUS OE: 3574200538	1 & 2 Right & Left	26	4W2040	N/A			
				KB2040				
				72059				
EBS2045	MERCEDES TRUCK & BUS OE: 6174200238	1 & 2 Right & Left	26	4W2045	N/A			
				KB2045				
				70954C				
EBS2050	MERCEDES TRUCK OE: 6524200138	1 Right	26	4W2050	EBS2055			
				KB2050				
				72594				
EBS2055	MERCEDES TRUCK OE: 6524200038	2 Left	26	4W2055	EBS2050			
				KB2055				
				72593				
EBS2060	MERCEDES TRUCK OE: 6174200438	1 Right	26	4W2060	EBS2065			
				KB2060				
				70953				
EBS2065	MERCEDES TRUCK OE: 6524200338	2 Left	26	4W2065	EBS2060			
				KB2065				
				70952				
EBS2100	MERCEDES BUS OE: 3074200338	1 & 2 Right & Left	26	4W2100	N/A			
				KB2100				
				70775C				
EBS2130	MERCEDES BUS OE: 3014201138	1 & 2 Right & Left	26	4W2130	N/A			
				KB2130				
				72213				
EBS2135	MERCEDES TRUCK OE: 3834200438	1 Right	26	4W2135	EBS2140			
				KB2135				
				72036				



SLACK ADJUSTERS

**EBS AUTOMATIC SLACK ADJUSTERS - TRUCK & BUS - MERCEDES**

EBS Part No.	Application	Fitment Position (Chart - P.25.4)	Spline Teeth No	Alternative	Opposite Hand	Image	
EBS2140	MERCEDES TRUCK OE: 3834200538	2	26	4W2140	EBS2135		
		Left		KB2140			
		72037					
EBS2150	MERCEDES TRUCK OE: 3894200738	1 & 2	26	4W2150	N/A		
		Right & Left		KB2150			
		70867C					
EBS2155	MERCEDES TRUCK OE: 3874200138	1	26	4W2155	EBS2160		
		Right		KB2155			
		72174					
EBS2160	MERCEDES TRUCK OE: 3874200038	2	26	4W2160	EBS2155		
		Left		KB2160			
		72173					
EBS2420	MERCEDES TRUCK & BUS OE: 6524200238	1 & 2	26	4W2420	N/A		
		Right & Left		KB2420			
		72596					
EBS2440	MERCEDES BUS OE: 3054202638	1 & 2	26	4W2440	N/A		
		Right & Left		KB2440			
		70706C					
EBS2715	MERCEDES BUS OE: 3574201138	2	26	72211C	EBS2720		
		Left		KB2715			
EBS2720	MERCEDES BUS OE: 3574201238	1	26	72212C	EBS2715		
		Right		KB2720			
EBS2750	MERCEDES TRUCK OE: 6234200738	1	26	4W2750	EBS2755		
		Right		KB2750			
				72038			

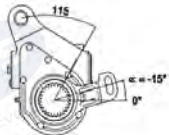

**EBS AUTOMATIC SLACK ADJUSTERS - TRUCK & BUS - MERCEDES**

EBS Part No.	Application	Fitment Position (Chart - P25.4)	Spline Teeth No	Alternative	Opposite Hand	Image		
EBS2755	MERCEDES TRUCK OE: 6234200638		26	4W2755	EBS2750			
				KB2755				
				72039				
EBS2930	MERCEDES BUS OE: 3574201338		26	4W2930	EBS3155			
				KB2930				
				72809				
EBS3125	MERCEDES BUS OE: 3074200138	2	26	4W3125	EBS3130			
				KB3125				
		Left	70772					
EBS3130	MERCEDES BUS OE: 3074200238	1	26	4W3130	EBS3125			
				KB3130				
		Right	70771					
EBS3145	MERCEDES TRUCK OE: 3854201738	2	26	4W3145	EBS3150			
				KB3145				
				Left				
EBS3150	MERCEDES TRUCK OE: 3854201838	1	26	4W3150	EBS3145			
				KB3150				
		Right	72041					
EBS3155	MERCEDES BUS OE: 3574201438	1	26	4W3155	EBS2930			
				KB3155				
				Right				
EBS3480	MERCEDES BUS OE: 3454201238	1 & 2	26	4W3480	N/A			
				KB3480				
		Right & Left	72178					
EBS3795	MERCEDES TRUCK OE: 6234200038	2	26	4W3795	EBS3800			
				KB3795				
		Left	72054					

SLACK ADJUSTERS

**EBS AUTOMATIC SLACK ADJUSTERS - TRUCK & BUS - MERCEDES**

EBS Part No.	Application	Fitment Position (Chart - P25-4)	Spline Teeth No	Alternative	Opposite Hand	Image	
EBS3800	MERCEDES TRUCK OE: 6234200138	1 Right	26	4W3800	EBS3795		
				KB3800			
				72055			
EBS3815	MERCEDES BUS OE: 3574201538	2 Left	26	4W3815	EBS3820		
				KB3815			
				72811			
EBS3820	MERCEDES BUS OE: 3574201638	1 Right	26	4W3820	EBS3815		
				KB3820			
				72812			
EBS4010	MERCEDES BUS OE: 3574200638	1 Right	26	4W4010	EBS4015		
				KB4010			
				72060			
EBS4015	MERCEDES BUS OE: 3574200738	2 Left	26	4W4015	EBS4010		
				KB4015			
				72061			
EBS4170	MERCEDES TRUCK OE: 3934200038	1 & 2 Right & Left	26	4W4170	N/A		
				KB7140			
				70870			
EBS4415	MERCEDES: 0003520840	Left	19	4W4415	EBS4420		
				79637C			
EBS4420	MERCEDES: 0003520940	Right	19	79638C	EBS4415		
				4W4420			
EBS4500	MERCEDES TRUCK OE: 3844207438	2 Left	26	---	N/A		
				---			
				79186			

**EBS AUTOMATIC SLACK ADJUSTERS - TRUCK & BUS - MERCEDES**

EBS Part No.	Application	Fitment Position (Chart - P23.4)	Spline Teeth No	Alternative	Opposite Hand	Image		
25.80.0000	MERCEDES ACTROS OE: 9454200238 Self-setting Automatic Slack Adjuster	Left	26	6Y6500	25.80.0001			
				KB6500				
				80000C				
25.80.0001	MERCEDES ACTROS OE: 9454200338 Self-setting Automatic Slack Adjuster	Right	26	6Y6505	25.80.0000			
				KB6505				
				80001C				
25.80.0008	MERCEDES ACTROS OE: 9454200038 Self-setting Automatic Slack Adjuster	Left	26	6Y6510	25.80.0009			
				KB6510				
				80008C				
25.80.0009	MERCEDES ACTROS OE: 9454200138 Self-setting Automatic Slack Adjuster	Right	26	6Y6515	25.80.0008			
				KB6515				
				80009C				
25.80.0010	MERCEDES ACTROS OE: 9454200838 Self-setting Automatic Slack Adjuster	Left	26	6Y6520	25.80.0011			
				KB6520				
				80010C				
25.80.0011	MERCEDES ACTROS OE: 9454200738 Self-setting Automatic Slack Adjuster	Right	26	6Y6525	25.80.0010			
				KB6525				
				80011C				
25.80.0014	MERCEDES ACTROS OE: 9454200438 Self-setting Automatic Slack Adjuster	Left	26	6Y6540	25.80.0030			
				KB6540				
				80014C				
25.80.0030	MERCEDES ACTROS OE: 9454200938 Self-setting Automatic Slack Adjuster	Right	26	6Y6545	25.80.0014			
				KB6545				
				80030C				

SLACK ADJUSTERS

**EBS AUTOMATIC SLACK ADJUSTERS - TRUCK & BUS - NEOPLAN**

EBS Part No.	Application	Fitment Position (Chart - P25.4)	Spline Teeth No	Alternative	Opposite Hand	Image	
EBS2505	NEOPLAN BUS OE: B510643	2	19	4W2505	EBS2510		
				KB2505			
		Left		72203			
EBS2510	NEOPLAN BUS OE: B510642	1	19	4W2510	EBS2505		
				Right			
				72204			

**EBS AUTOMATIC SLACK ADJUSTERS - TRUCK & BUS - OPTARE**











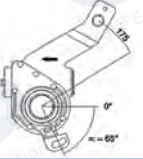

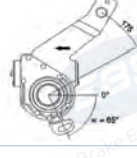

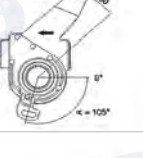

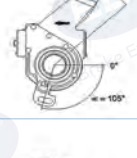
EBS Part No.	Application	Fitment Position (Chart - P25.4)	Spline Teeth No	Alternative	Opposite Hand	Image	
EBS2955	OPTARE BUS OE: L2220055	1 & 2	28	4W2955	N/A		
		Right & Left		KB2955			
				79177			

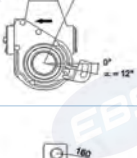

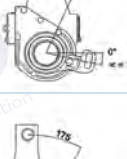
**EBS AUTOMATIC SLACK ADJUSTERS - TRUCK & BUS - RABA**

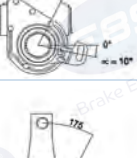
EBS Part No.	Application	Fitment Position (Chart - P25.4)	Spline Teeth No	Alternative	Opposite Hand	Image	
EBS3950	RABA	---	20	72928C	N/A		

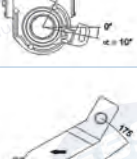
**EBS AUTOMATIC SLACK ADJUSTERS - TRUCK & BUS - RENAULT**











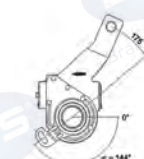

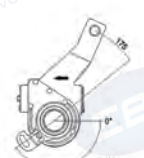

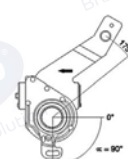

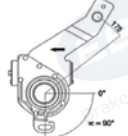

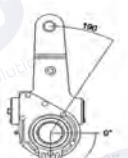
EBS Part No.	Application	Fitment Position (Chart - P25.4)	Spline Teeth No	Alternative	Opposite Hand	Image	
EBS2230	RENAULT TRUCK OE: 5010056686	2  Left	27	4W2230	EBS2240		
				KB2230			
				79014			
EBS2240	RENAULT TRUCK OE: 5010056685	1  Right	27	4W2240	EBS2230		
				KB2240			
				79013			
EBS2630	RENAULT TRUCK OE: 5010098862	2  Left	27	4W2630	EBS2635		
				KB2630			
				79296			
EBS2635	RENAULT TRUCK OE: 5010098863	1  Right	27	4W2635	EBS2630		
				KB2635			
				79297			
EBS2640	RENAULT TRUCK OE: 5010216843	2  Left	27	4W2640	EBS2645		
				KB2640			
				79229C			
EBS2645	RENAULT TRUCK OE: 5010216844	1  Right	27	4W2645	EBS2640		
				KB2645			
				79300			
EBS2795	RENAULT TRUCK OE: 5000791212	2  Left	27	4W2795	EBS2800		
				KB2795			
				79017			
EBS2800	RENAULT TRUCK OE: 5000791213	1  Right	27	4W2800	EBS2795		
				KB2800			
				79018			
EBS2815	RENAULT TRUCK & BUS OE: 500078264	1  Right	27	4W2815	EBS2820		
				KB2815			
				79007			

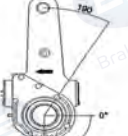
SLACK ADJUSTERS

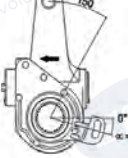
**EBS AUTOMATIC SLACK ADJUSTERS - TRUCK & BUS - RENAULT**

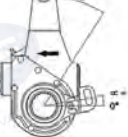
EBS Part No.	Application	Fitment Position (Chart - P25.4)	Spline Teeth No	Alternative	Opposite Hand	Image		
EBS2820	RENAULT TRUCK & BUS OE: 5000787265	2 Left	27	4W2820	EBS2815			
				KB2820				
				79008				
EBS2905	RENAULT TRUCK OE: 5010098831	1 Right	28	4W2905	EBS2910			
				KB2905				
				79288				
EBS2910	RENAULT TRUCK OE: 5010098832	2 Left	28	4W2910	EBS2905			
				KB2910				
				79289				
EBS2920	RENAULT TRUCK OE: 5010098860	1 Right	27	4W2920	EBS2925			
				KB2920				
				79294				
EBS2925	RENAULT TRUCK OE: 5010098861	2 Left	27	4W2925	EBS2920			
				KB2925				
				79295				
EBS2940	RENAULT TRUCK OE: 5010216904	1 Right	27	4W2940	EBS2945			
				KB2940				
				79301				
EBS2945	RENAULT TRUCK OE: 5010216905	2 Left	27	4W2945	EBS2940			
				KB2945				
				79302				
EBS3040	RENAULT TRUCK OE: 5010260117	1 Right	27	4W3040	EBS3045			
				KB3040				
				79310				
EBS3045	RENAULT TRUCK OE: 5010260118	2 Left	27	4W3045	EBS3040			
				KB3045				
				79311				

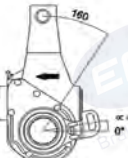
**EBS AUTOMATIC SLACK ADJUSTERS - TRUCK & BUS - RENAULT**

EBS Part No.	Application	Fitment Position (Chart - P25.4)	Spline Teeth No	Alternative	Opposite Hand	Image		
EBS3050	RENAULT TRUCK OE: 5010260116	1 Right	27	4W3050	EBS3055			
				KB3050				
				79309				
EBS3055	RENAULT TRUCK OE: 5010260115	2 Left	27	4W3055	EBS3050			
				KB3055				
				79308				
EBS3085	RENAULT BUS OE: 5010013393	1 Right	27	79020C	EBS3090			
EBS3090	RENAULT BUS OE: 5010013394	2 Left	27	79021C	EBS3085			
EBS3195	RENAULT TRUCK & BUS OE: 5000785205	2 Left	27	4W3195	EBS3200			
				KB3195				
				79150				
EBS3200	RENAULT TRUCK & BUS OE: 5000785206	1 Right	27	4W3200	EBS3195			
				KB3200				
				79151				
EBS3205	RENAULT TRUCK OE: 5000445830	1 & 2 Right & Left	27	4W3205	N/A			
				KB3205				
				79011				
EBS3485	RENAULT TRUCK OE: 5010260027	2 Left	28	4W3485	EBS3490			
				KB3485				
				79304				
EBS3490	RENAULT TRUCK OE: 5010260028	1 Right	28	4W3490	EBS3485			
				KB3490				
				79305				









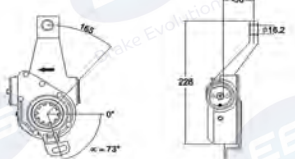

SLACK ADJUSTERS

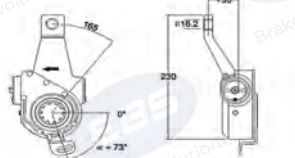
**EBS AUTOMATIC SLACK ADJUSTERS - TRUCK & BUS - RENAULT**

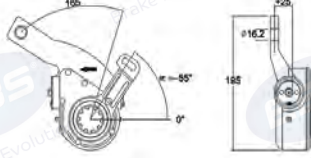
EBS Part No.	Application	Fitment Position (Chart - P25.4)	Spline Teeth No	Alternative	Opposite Hand	Image	
EBS3755	RENAULT TRUCK OE: 5010197578	---	27	4W3755	EBS4200		
				KB3755			
				79441			
EBS3825	RENAULT TRUCK OE: 5000788696	---	27	4W3825	EBS3830		
				KB3825			
		Right		79009			
EBS3830	RENAULT TRUCK OE: 5000788697	2	27	4W3830	EBS3825		
		Left		KB3830			
				79010			
EBS3840	RENAULT TRUCK OE: 5010260023	2	27	4W3840	EBS3845		
		Left		KB3840			
				79306			
EBS3845	RENAULT TRUCK OE: 5010260024	1	27	4W3845	EBS3840		
		Right		KB3845			
				79307			
EBS4200	RENAULT OE: 5010197577	---	27	4W4200	EBS3755		
		---		KB4200			
		---		79440			
EBS9683	RENAULT OE: 5430060289	---	27	4W4460	EBS9684		
		---		KB4460			
		---		79683C			
EBS9684	RENAULT OE: 5430060288	---	27	4W4465	EBS9683		
		---		KB4465			
		---		79684C			

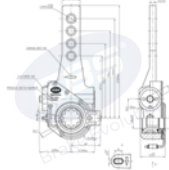

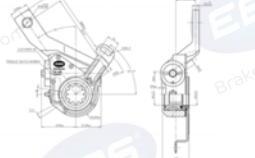
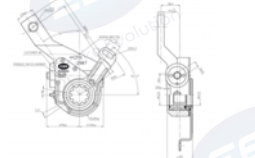
**EBS AUTOMATIC SLACK ADJUSTERS - TRUCK & BUS - SCANIA**

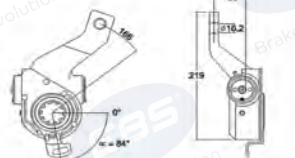





EBS Part No.	Application	Fitment Position (Chart - P25.4)	Spline Teeth No	Alternative	Opposite Hand	Image	
EBS2210	SCANIA TRUCK & BUS OE: 1112830	1 Right	10	4W2210	EBS2215		
				KB2210			
				72264			
EBS2215	SCANIA TRUCK & BUS OE: 1112829	2 Left	10	4W2215	EBS2210		
				KB2215			
				72263			
EBS2220	SCANIA TRUCK & BUS OE: 1112833	2 Left	10	4W2220	EBS2260		
				KB2220			
				72660			
EBS2249	SCANIA OE: 633107720	1 & 2 Right & Left	10	72249	N/A		
EBS2250	SCANIA TRUCK & BUS OE: 1112831	1 & 2 Right & Left	10	4W2250	N/A		
				KB2250			
				72662C			
EBS2260	SCANIA TRUCK & BUS OE: 1112834	1 Right	10	4W2260	EBS2220		
				KB2260			
				72661			
EBS2265	SCANIA TRUCK & BUS OE:	1 Right	10	4W2265	EBS2270		
				KB2265			
				72745C			
EBS2270	SCANIA TRUCK & BUS OE:	2 Left	10	4W2270	EBS2265		
				KB2270			
				72744C			
EBS2360	SCANIA BUS OE: 1112839	2 Left	10	4W2360	EBS2595		
				KB2360			
				72825			

SLACK ADJUSTERS

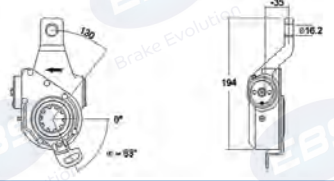
**EBS AUTOMATIC SLACK ADJUSTERS - TRUCK & BUS - SCANIA**

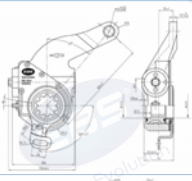
EBS Part No.	Application	Fitment Position (Chart - P25.4)	Spline Teeth No	Alternative	Opposite Hand	Image		
EBS2585	SCANIA TRUCK & BUS OE: 394189	1 Right	10	4W2585	EBS2590			
				KB2585				
				72727				
EBS2590	SCANIA TRUCK & BUS OE: 394190	2 Left	10	4W2590	EBS2585			
				KB2590				
				72728				
EBS2595	SCANIA BUS OE:1112840	1 Right	10	4W2595	EBS2360			
				KB2595				
				72826				
EBS2710	SCANIA TRUCK & BUS OE: 1112841	1 & 2 Right & Left	10	4W2710	N/A			
				KB2710				
				72654				
EBS2735	SCANIA TRUCK & BUS OE: 1358634	1 Right	10	4W2735	EBS2740			
				KB2735				
				79033 79442C				
EBS2740	SCANIA TRUCK & BUS OE: 1358635	2 Left	10	4W2740	EBS2735			
				KB2740				
				79034 79443C				
EBS3315	SCANIA BUS EO: 321469	2 Left	10	4W3315	EBS3320			
				KB3315				
				72955C				
EBS3320	SCANIA BUS OE: 321470	1 Right	10	4W3320	EBS3315			
				KB3320				
				72954				
EBS3520	SCANIA TRUCK OE: 394195	1 Right	10	4W3520	EBS3525			
				KB3520				
				72729				

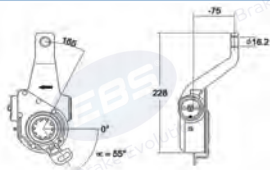
**EBS AUTOMATIC SLACK ADJUSTERS - TRUCK & BUS - SCANIA**

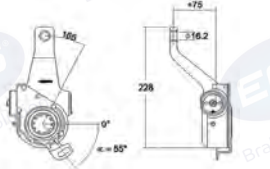
EBS Part No.	Application	Fitment Position (Chart - P25.4)	Spline Teeth No	Alternative	Opposite Hand	Image	
EBS3525	SCANIA TRUCK OE: 394196	2	10	4W3525	EBS3520		
		Left		KB3525			
		72730					
EBS3540	SCANIA OE: 5021173921	1 & 2	10	79348C	EBS3545		
		Right & Left					
EBS3545	SCANIA	1 & 2	10	79347C	EBS3540		
		Right & Left					
EBS3550	DAF TRUCK OE: 219860	2	10	4W3550	EBS3555		
		Left		KB3550			
				79105			
EBS3555	DAF TRUCK OE: 219859	1	10	4W3555	EBS3550		
		Right		KB3555			
				79106			

**EBS AUTOMATIC SLACK ADJUSTERS - TRUCK & BUS - SISU**

EBS Part No.	Application	Fitment Position (Chart - P25.4)	Spline Teeth No	Alternative	Opposite Hand	Image	
EBS3965	SISU TRUCK & BUS OE:	---	26	79396C	EBS3970	 	
EBS3970	SISU TRUCK & BUS OE:	---	26	79397C	EBS3965	 	
EBS4315	SISU TRUCK & BUS OE:	---	26	4W4315	EBS4320		
		---		KB4315			
		---		79407C			
EBS4320	SISU TRUCK & BUS OE:	---	26	4W4320	EBS4315		
		---		KB4320			
		---		79408C			

SLACK ADJUSTERS

**EBS AUTOMATIC SLACK ADJUSTERS - TRUCK & BUS - VAN HOOL**

EBS Part No.	Application	Fitment Position (Chart - P25.4)	Spline Teeth No	Alternative	Opposite Hand	Image		
EBS2775	VAN HOOL BUS OE: 633104610	2 Left	19	4W2775	EBS2780			
				KB2775				
				72459				
EBS2780	VAN HOOL BUS OE: 633104620	1 Right	19	4W2780	EBS2775			
				KB2780				
				72460				
EBS3030	VAN HOOL BUS OE: 633104690	1 Right	19	4W3030	EBS3035			
				KB3030				
				72462				
EBS3035	VAN HOOL BUS OE: 633104700	2 Left	19	4W3035	EBS3030			
				KB3035				
				72461				

**EBS AUTOMATIC SLACK ADJUSTERS - TRUCK & BUS - VOLVO**

EBS Part No.	Application	Fitment Position (Chart - P25.4)	Spline Teeth No	Alternative	Opposite Hand	Image		
EBS2275	VOLVO BUS OE: 1196321	1 & 2 Right & Left	10	4W2275	N/A			
				KB2275				
				72678				
EBS2280	VOLVO BUS OE: 1195461	2 Left	10	4W2280	EBS2300			
				KB2280				
				72782				
EBS2285	VOLVO BUS OE: 1136432	2 Left	10	4W2285	EBS2290			
				KB2285				
				72723				
EBS2290	VOLVO BUS OE: 1196433	1 Right	10	4W2290	EBS2285			
				KB2290				
				72724				
EBS2295	VOLVO BUS OE: 1196322	1 & 2 Right & Left	10	4W2295	N/A			
				KB2295				
				72726				

**EBS AUTOMATIC SLACK ADJUSTERS - TRUCK & BUS - VOLVO**

EBS Part No.	Application	Fitment Position (Chart - P25.4)	Spline Teeth No	Alternative	Opposite Hand	Image		
EBS2300	VOLVO BUS OE: 1195462	1 Right	10	4W2300	EBS2280			
				KB2300				
				72783				
EBS2540	VOLVO TRUCK OE: 1586192	1 Right	10	4W2540	EBS2545			
				KB2540				
				72670				
EBS2545	VOLVO TRUCK OE: 1586193	2 Left	10	4W2545	EBS2540			
				KB2545				
				72671				
EBS2575	VOLVO BUS OE: 1134293	2 Left	10	4W2575	EBS2580			
				KB2575				
				72717				
EBS2580	VOLVO BUS OE: 1134294	1 Right	10	4W2580	EBS2575			
				KB2580				
				72718				
EBS3135	VOLVO BUS OE: 1197966	2 Left	10	4W3135	EBS3140			
				KB3135				
				72785				
EBS3140	VOLVO BUS OE: 1197965	1 Right	10	4W3140	EBS3135			
				KB3140				
				72784				
EBS3210	VOLVO BUS OE: 1134452	1 Right	10	4W3210	N/A			
				KB3210				
				72720C				
EBS3710	VOLVO TRUCK OE: 1592875	1 & 2 Right & Left	10	4W3710	N/A			
				KB3710				
				72725				
EBS3805	VOLVO BUS OE: 1134829	2 Left	10	4W3805	EBS3810			
				KB3805				
				72721				

SLACK ADJUSTERS

**EBS AUTOMATIC SLACK ADJUSTERS - TRUCK & BUS - VOLVO**

EBS Part No.	Application	Fitment Position (Chart - P25.4)	Spline Teeth No	Alternative	Opposite Hand	Image	
EBS3810	VOLVO BUS OE: 1134830	1 Right	10	4W3810	EBS3805		
				KB3810			
				72722			
EBS3910	VOLVO BUS OE: 3193400	2 Left	10	4W3910	EBS3915		
				KB3910			
				79677			
EBS3915	VOLVO BUS OE: 3193401	1 Right	10	4W3915	EBS3910		
				KB3915			
				79678			
EBS4255	VOLVO BUS	1 Right	10	---	EBS4260		
				---			
				79641C			
EBS4260	VOLVO BUS	2 Left	10	---	EBS4255		
				---			
				79642C			

**EBS AUTOMATIC SLACK ADJUSTERS - TRUCK & BUS - ZF AXLES**

EBS Part No.	Application	Fitment Position (Chart - P25.4)	Spline Teeth No	Alternative	Opposite Hand	Image	
EBS2785	LIAZ BUS OE: 070276010	---	19	4W2785	EBS2790		
				KB2785			
				72688			
EBS2790	LIAZ BUS OE: 070276011	---	19	4W2790	EBS2785		
				KB2790			
				72689			
EBS3295	ZF AXLE OE: 0501207555	1 & 2 Right & Left	19	4W3295	N/A		
				KB3295			
				72641			

## TRAILER FITMENT POSITION GUIDE

Where possible EBS has detailed to which side of the vehicle the EBS slack adjuster reference is fitted.

The information we have provided within this section should only be used as a guide.

The guaranteed way of selecting the correct replacement EBS product is to identify the actual reference of the item that is being removed from the vehicle itself.

Please note - as the information is not always available this is only an indication of the applications suited for each EBS reference.

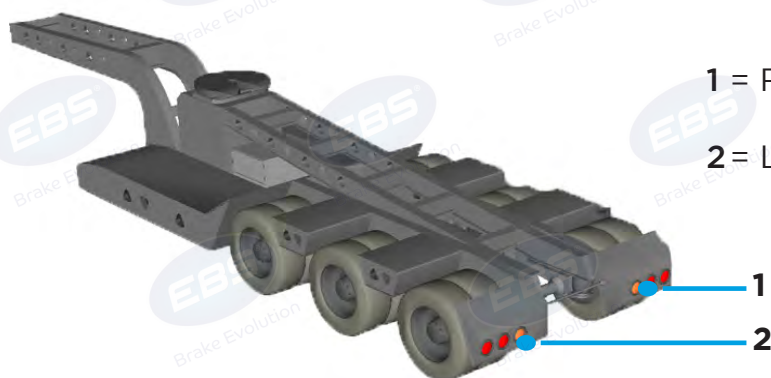

1 = Right Hand Side Of Vehicle Fitment

2 = Left Hand Side Of Vehicle Fitment

EBS AUTOMATIC SLACK ADJUSTERS - TRAILER - BPW						
EBS Part No.	Application	Fitment Position (Chart - P25.4)	Spline Teeth No	Alternative	Opposite Hand	Image
EBS1005	BPW AXLE FAST FIT OE: 0517482212	1 & 2	10	4W1005	N/A	
		Right & Left		KB1005		
				72875		
EBS1010	BPW AXLE FAST FIT OE: 0517482242	1 & 2	10	4W1010	N/A	
		Right & Left		KB1010		
				72876		
EBS1125	BPW AXLE FAST FIT OE:	1 & 2	10	4W1125	N/A	
		Right & Left		KB1125		
				72053C		
25.80.0019	BPW AXLE FAST FIT OE: 0557482873 Self-setting Automatic Slack Adjuster	1 & 2	10	4W1046	N/A	
		Right & Left		KB1046		
				80019		

**EBS AUTOMATIC SLACK ADJUSTERS - TRAILER - FRUEHAUF**

EBS Part No.	Application	Fitment Position (Chart - P25.4)	Spline Teeth No	Alternative	Opposite Hand	Image
EBS1020	FRUEHAUF AXLE FAST FIT OE: AJB0743001	1 & 2	37	4W1020	N/A	
		Right & Left		KB1020		
				79022		
25.80.0021	FRUEHAUF AXLE FAST FIT OE: AJB0743001 Self-setting Automatic Slack Adjuster	1 & 2	37	6Y1510	N/A	
		Right & Left		KB1510		
				80021D		

**EBS SLACK ADJUSTERS - GIGANT**

EBS Part No.	Application	Fitment Position (Chart - P25.4)	Spline Teeth No	Alternative	Opposite Hand	Image
25.80.0108	GIGANT OE: 09319434	1 & 2	10	6Y1550	N/A	
		Right & Left		80108		
EBS1270	GIGANT OE: 09319456	1 & 2	10	4W1270	N/A	
		Right & Left		79149		
EBS1320	GIGANT	1 & 2	10	79138C	EBS1325	
		Right & Left				
EBS1325	GIGANT	1 & 2	10	79139C	EBS1320	
		Right & Left				
25.80.0134	GIGANT OE: 09319440	1 & 2	10	6Y1580	N/A	
		Right & Left		80134C		



**EBS AUTOMATIC SLACK ADJUSTERS - TRAILER - MERITOR (ROR)**

EBS Part No.	Application	Fitment Position (Chart - P25.4)	Spline Teeth No	Alternative	Opposite Hand	Image
EBS1000 <small>See Also EBS2788</small>	MERITOR AXLE FAST FIT OE: 21223694 "Knuckle" Style Lever	1 & 2	10	4W1000	N/A	 <p>Control arm brackets also available separately. EBS Refs ZJ117 &amp; ZJ118 - See Page 25.40</p> 
		Right & Left		KB1000		
		72788				
EBS1025	MERITOR	1 & 2	10	4W1025	N/A	 
		Right & Left		KB1025		
		79004				
EBS1055	MERITOR OE: 21217569	1 & 2	10	4W1055	N/A	 
		Right & Left		KB1055		
		72261				
EBS1065	MERITOR	1 & 2	10	4W1065	N/A	 
		Right & Left		KB1065		
		72256				
EBS1085	MERITOR STEER AXLE OE: 21229280	2	10	4W1085	EBS1090	 
		Left		KB1090		
				79097		
EBS1090	MERITOR STEER AXLE OE: 21229281	1	10	4W1090	EBS1085	 
		Right		KB1085		
				79098		
EBS1170	MERITOR OE: 21229290	1 & 2	10	79183C	N/A	 
		Right & Left		KB1170		
		2122929				
EBS1180	MERITOR	1 & 2	10	79160	N/A	 
		Right & Left				
EBS1315	MERITOR	1 & 2	28	4W1315	N/A	 
		Right & Left		KB1315		
				79504C		

SLACK ADJUSTERS

**EBS AUTOMATIC SLACK ADJUSTERS - TRAILER - SAE**

EBS Part No.	Application	Fitment Position (Chart - P25.4)	Spline Teeth No	Alternative	Opposite Hand	Image	
25.80.0124	SAE	---	10	80124C	25.80.0125		
	OE: 09319437	---		6Y1560			
	---	09319437					
25.80.0125	SAE	---	10	80125C	25.80.0124		
	OE: 09319438	---		6Y1565			
	---	09319438					
EBS2788 <small>See Also EBS1000</small>	MERITOR AXLE FAST FIT OE: 21223694 "U" Style Lever	1 & 2	10	4W1000	N/A	 <small>Control arm brackets also available separately. EBS Refs ZJ117 &amp; ZJ118 - See Page 25-40</small>	
		Right & Left		KB1000			
				72788			
25.80.0020	MERITOR OE: 21229249 Self-setting Automatic Slack Adjuster	1 & 2	10	6Y1505	N/A		
		Right & Left		KB1505			
				80020			
EBS1030	SAF AXLE FAST FIT OE: 4175024900	1 & 2	10	4W1030	N/A		
		Right & Left		KB1030			
				79005			
EBS1035	SAF AXLE FAST FIT OE: 4175024000	1 & 2	10	4W1035	N/A		
		Right & Left		KB1035			
				72948			
EBS1040	SAF AXLE FAST FIT OE: 4175024800	1 & 2	10	4W1040	N/A		
		Right & Left		KB1040			
				79035			

**EBS AUTOMATIC SLACK ADJUSTERS - TRAILER - SAF**

EBS Part No.	Application	Fitment Position (Chart - P25.4)	Spline Teeth No	Alternative	Opposite Hand	Image	
EBS1075	SAF	1 & 2	10	4W1075	N/A		
		Right & Left		KB1075			
				72250C			
EBS1080	SAF AXLE FAST FIT OE: 4175014100	1 & 2	10	4W1080	N/A		
		Right & Left		KB1080			
				70949C			
EBS1110	SAF STEER AXLE PEG TYPE OE: 4175014000	1	10	4W1110	EBS1160		
		Right		KB1110			
				72239			
EBS1115	SAF PEG TYPE	1	10	4W1115	EBS1120		
		Right		KB1115			
EBS1120	SAF PEG TYPE	2	10	4W1120	EBS1115		
		Left		KB1120			
				70803			
EBS1130	SAF PEG TYPE	1	10	4W1130	EBS1135		
		Right		KB1130			
				72008			
EBS1135	SAF STEER AXLE PEG TYPE OE: 4175014900	2	10	4W1135	EBS1130		
		Left		KB1135			
				72007			
EBS1160	SAF STEER AXLE PEG TYPE OE: 4175013900	2	10	4W1160	EBS1110		
		Left		KB1160			
				72238			
EBS1330	SAF OE: 4175023500	1	10	4W1330	EBS1335		
		Right		KB1330			
				79043C			

SLACK ADJUSTERS

**EBS AUTOMATIC SLACK ADJUSTERS - TRAILER - SAF**

EBS Part No.	Application	Fitment Position (Chart - P25.4)	Spline Teeth No	Alternative	Opposite Hand	Image
EBS1335	SAF OE: 4175023600	2	10	4W1335	EBS1330	
		Left		KB1335		
				79044C		
EBS1605E	SAF OE: 4175037400	1 & 2	10	80295	N/A	
		Right & Left		4175037400		
EBS9792	SAF	1	10	---	EBS9793	
		Right		79792C		
EBS9793	SAF	2	10	---	EBS9792	
		Left		79793C		
25.80.0022 Supplied Singular See Also 25.80.0022D	SAF OE: 4175024900  Self-setting Automatic Slack Adjuster	1 & 2	10	6Y1515	N/A	
		Right & Left		80022S		
25.80.0022D Supplied As a Boxed Pair See Also 25.80.0022	SAF OE: 4175024900  Self-setting Automatic Slack Adjuster	1 & 2	10	6Y1515	N/A	
		Right & Left		KB1515		
				80022D		
25.80.0041	SAF OE: 4175026200  Self-setting Automatic Slack Adjuster	1 & 2	10	6Y1535	N/A	
		Right & Left		KB1535		
				80041		

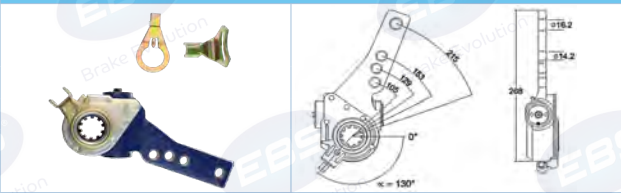
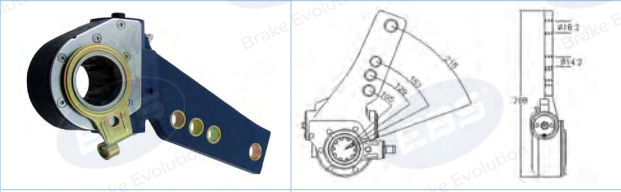
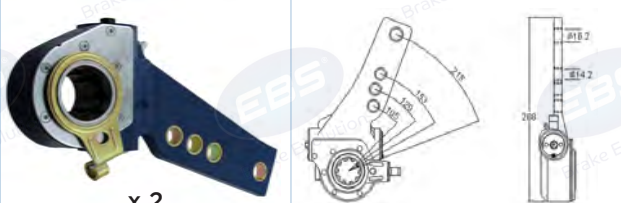
EBS AUTOMATIC SLACK ADJUSTERS - TRAILER - SMB						
EBS Part No.	Application	Fitment Position (Chart - P25.4)	Spline Teeth No	Alternative	Opposite Hand	Image
EBS1025	SMB AXLE FAST SIT OE: MO02416	1 & 2	10	4W1025	N/A	
		Right & Left		KB1025		
				79004		
25.80.0023 Supplied Singular See Also 25.80.0022	SMB AXLE FAST SIT OE: MO02416	1 & 2	10	6Y1520	N/A	
		Right & Left		KB1520		
				80023S		
25.80.0023D Supplied As a Boxed Pair See Also 25.80.0022	SMB AXLE FAST SIT OE: MO02416	1 & 2	10	6Y1520	N/A	
		Right & Left		KB1520		
				80023D		

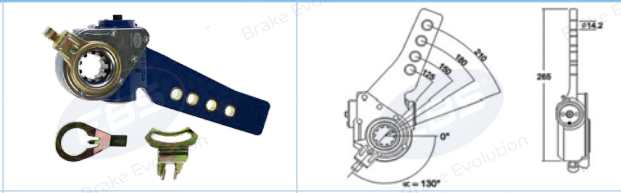
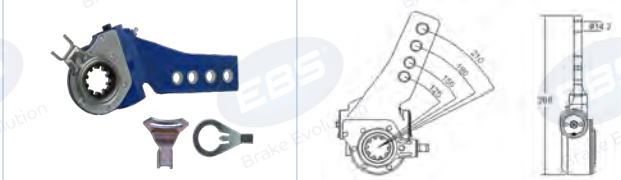
EBS SLACK ADJUSTERS - TRAILER						
EBS Part No.	Application	Fitment Position (Chart - P25.4)	Spline Teeth No	Alternative	Opposite Hand	Image
EBS1015	TRAILOR OE: 9002105	1 & 2	10	4W1015	N/A	
		Right & Left		72254C		
				79023D		
				79023S		
25.80.0024	TRAILOR OE: TO017649Z	1 & 2	10	6Y1525	N/A	
		Right & Left		KB1525		
				80024		

EBS SLACK ADJUSTERS - UNIVERSAL						
EBS Part No.	Application	Fitment Position (Chart - P25.4)	Spline Teeth No	Alternative	Opposite Hand	Image
EBS1137	UNIVERSAL	1 & 2	10	SBT21137	N/A	
		Right & Left				

SLACK ADJUSTERS















**EBS MANUAL SLACK ADJUSTERS**

EBS Part No.	Information	Fitment Position (Chart - P25.4)	Spline Teeth No	Alternative	Opposite Hand	Image	Repair Kit
25.00.1005	BPW	1 & 2	10	100001721	N/A		---
		Straight		05.174.52.61.0			
25.00.1006	MERITOR	1 & 2	10	100101047	N/A		---
		Straight					
N264432	Manual Slack Adjuster	2	10	264432	N264433		---
		Left					
N264433	Manual Slack Adjuster	1	10	264433	N264432		---
		Right					
N267026	Manual Slack Adjuster PL24 25mm Offset	---	10	267026	N267027		---
		---					
N267027	Manual Slack Adjuster PL24 25mm Offset	---	10	267027	N267026		---
		---					
N267083	Manual Slack Adjuster PL18 50mm Offset	2	10	267083	N267084		---
		Left					
N267084	Manual Slack Adjuster PL18 50mm Offset	1	10	267084	N267083		---
		Right					
N274971	Manual Slack Adjuster PL30 Straight	1 & 2	10	274971	N/A		---
		Right & Left					

EBS MANUAL SLACK ADJUSTERS							
EBS Part No.	Information	Fitment Position (Chart - P25.4)	Spline Teeth No	Alternative	Opposite Hand	Image	Repair Kit
N281966	Manual Slack Adjuster	1	10	281966	N281967		---
	PL20 38.1mm Offset	Right					
N281967	Manual Slack Adjuster	2	10	281967	N281966		---
	PL20 38.1mm Offset	Left					
---	Manual Slack Adjuster	1	10	295183	N295184		---
	PL24 22.2mm Offset	Right					
N295184	Manual Slack Adjuster	2	10	295184	N295183		---
	PL24 22.2mm Offset	Left					
N295567	Manual Slack Adjuster	---	10	295567	---		---
		---					

SLACK ADJUSTERS

**EBS REPAIR KITS - Z CAM**

<p><b>EKPP.4.1</b></p> 		<p><b>EKPP.4.2</b></p> 		<p><b>EKPP.4.3</b></p> 		<p><b>EKPP.4.4</b></p> 	
ALT. Part No.	272909 8550978 ST4014 3097099	ALT. Part No.	8550977 272908 ST4013 3091700	ALT. Part No.	6819150 1696924 ST1036 272906	ALT. Part No.	6819151 696925 ST1037 272907
APPLICATION	LEFT HAND	APPLICATION	RIGHT HAND	APPLICATION	LEFT HAND	APPLICATION	RIGHT HAND
<p><b>EKPP.4.5</b></p> 		<p><b>EKPP.4.6</b></p> 		<p><b>EKPP.4.7</b></p> 		<p><b>EKPP.4.8</b></p> 	
ALT. Part No.	3090954 68192410 1696448	ALT. Part No.	1696453 272910 SP8540 1696453	ALT. Part No.	272905	ALT. Part No.	ST1033
APPLICATION	---	APPLICATION	---	APPLICATION	---	APPLICATION	---
<p><b>EKPP.4.9</b></p> 		<p><b>EKPP.4.10</b></p> 		<p><b>EKPP.4.11</b></p> 		<p><b>EKPP.4.12</b></p> 	
ALT. Part No.	ST4011	ALT. Part No.	1696449	ALT. Part No.	3097092 1696444 5001868113 68192115 9C462296AA	ALT. Part No.	3097299 1698346
APPLICATION	---	APPLICATION	---	APPLICATION	---	APPLICATION	---
<p><b>EKPP.4.13</b></p> 		<p><b>EKPP.4.14</b></p> 					
ALT. Part No.	64225252 1696446	ALT. Part No.	ST1035				
APPLICATION	N/A	APPLICATION	N/A				



**EBS SLACK ADJUSTER REPAIR KIT - CONTROL ARMS**

ZJ117		ZJ118	
			
ALT. Part No.	---	ALT. Part No.	--
APPLICATION	FOR EBS1000 & EBS2788	APPLICATION	FOR EBS1000 & EBS2788

**EBS SLACK ADJUSTER REPAIR KIT - HALDEX 7 SERIES**

EBS Part No.	Alternative	Application	Image
EKGH.13S	76046 5001825536	HALDEX 7 SERIES AUTO SLACK ADJUSTERS	

**EBS SLACK ADJUSTERS REPAIR KITS - HALDEX**

EKWL.300	EKWL.301
	

**WEAR SENSOR CONNECTING CABLE**

30.11.10008	
	
ALT. Part No.	A0005404136

SLACK ADJUSTERS

