

COMPRESSORS

HALDEX COMPRESSORS

Alternative Part No



KNT86230

EKGH.6



KNORR SINGLE CYLINDER COMPRESSORS

Alternative Part No



1189499

EKKB.97.1

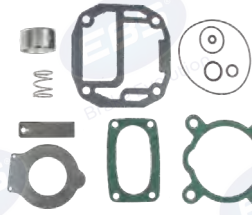

EKKB.97.CH



EKKB.97.CP



Alternative Part No



EKKB.9.R.STD



EKKB.9.RP.STD



EKKB.94



EKKB.94.CH



EKKB.94.IC

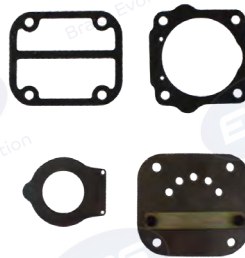

EKKB.94.CB



EKKB.94.CR



- | | | |
|--------|--------|--------|
| LK1300 | LK1521 | LK1553 |
| LK1303 | LK1522 | LK1559 |
| LK1304 | LK1523 | LK1560 |
| LK1305 | LK1524 | LK1561 |
| LK1314 | LK1525 | LK1566 |
| LK1325 | LK1527 | LK1567 |
| LK1327 | LK1532 | LK1568 |
| LK1500 | LK1533 | LK1585 |
| LK1503 | LK1534 | LK1587 |
| LK1504 | LK1535 | LK1588 |
| LK1506 | LK1537 | LK1596 |
| LK1511 | LK1539 | LP1527 |
| LK1517 | LK1543 | LP1537 |
| LK1518 | LK1545 | LP1567 |
| LK1519 | LK1550 | |
| LK1520 | LK1551 | |

KNORR SINGLE CYLINDER COMPRESSORS

<p>Alternative Part No</p> 	<p>EKKB.92.RP.STD (BOX CONTAINS TWO PISTONS AND RINGSET)</p> 	<p>EKKB.94.CR (FOR LK18 XX & LP18 XX)</p> 	<p>EKKB.95</p> 
	<p>LK1802 LK1808 LK1811 LK1812 LK1813 LK1814</p> <p>LK1900 LK1901 LK1907 LP1806 LP1828 LP1959</p>	<p>EKKB.95.CB (FOR LK1900/101/1907/ LP1959)</p> 	<p>EKKB.95.CH</p> 
	<p>EKKB.95.CR (FOR ALL LK19 Series)</p> 	<p>EKKB.95.1C</p> 	<p>EKKB.95.1CH (FOR LK1812/1814)</p> 
	<p>EKKB.102.CB (FOR LK18 XX & LP1828/LP1806)</p> 	<p>EKKB.96.RP.STD (FOR LP1828)</p> 	

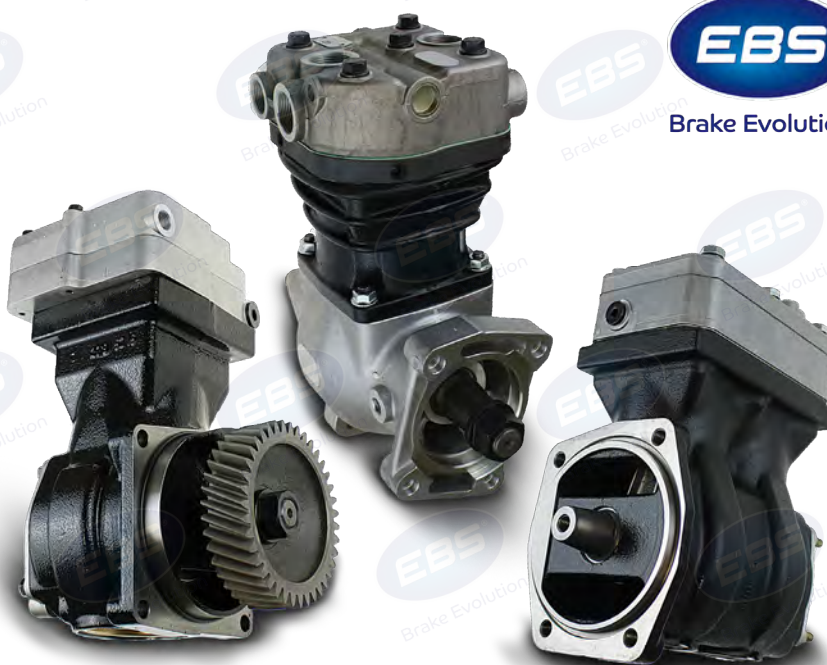

COMPRESSORS

ALL PISTON RINGS ARE AVAILABLE IN OVERSIZE ORDER RING SETS USING THIS RULE : (e.g. EK--.--.RP.STD = Standard size item.)
 e.g. EK--.--.RP.010= .010 oversize item./e.g. EK--.--.RP.020= .020 oversize item./e.g. EK--.--.RP.030= .030 oversize item./e.g. EK--.--.RP.040= .040 oversize item.

KNORR SINGLE CYLINDER COMPRESSORS



Alternative Part No	Image	Alternative Part No	Image
LK3802	1	LK3812	6
LK3826 LK3832 LK3868 LK3927	2	LK3914 LK3080	7
LK3963	3	LP3940	8
LP3993	4	LK3904	9
LK3908	5		



EKKB.92.RP.STD
(BOX CONTAINS TWO PISTONS AND RINGSET)

EKKB.94.CR
(FOR LK3802/LK3832/LK3914)

EKKB.95.CB

EKKB.95.CR

EKKB.99

EKKB.100

CRANK-GEAR9
(FOR LK3927)

EKKB.100.BU
(FOR LK3802 / LK3904)

EKKB.102.CB
(FOR LK3802)

EKKB.130

EKKB.427.5.CH

KNORR SINGLE CYLINDER COMPRESSORS

<p>Alternative Part No</p> 	<p>EKKB.92.RP.STD (BOX CONTAINS TWO PISTONS AND RINGSET)</p> 		<p>EKKB.94.CR (FOR LK18 XX & LP18 XX)</p> 	<p>EKKB.95.CR (FOR LK3972)</p> 
	<p>LK3813 LK3877 LK3970</p>	<p>LK3971 LK3972</p>	<p>EKKB.100</p> 	<p>EKKB.100.2</p> 
<p>EKKB.100.BU</p> 		<p>EKKB.102.CB (FOR LK3813/3877)</p> 		<p>EKKB.100.CH (FOR LK3813)</p> 

<p>Alternative Part No</p> 	<p>EKKB.92.RP.STD (BOX CONTAINS TWO PISTONS AND RINGSET)</p> 		<p>EKKB.95.CR (FOR LK3972)</p> 	<p>EKKB.100.BU</p> 
	<p>LK3963 LP3927 LP3813 LK3832</p>	<p>EKKB.100</p> 	<p>EKKB.100.1 (FOR LK3963)</p> 	<p>EKKB.100.3 (FOR LP3927)</p> 
<p>EKKB.100.CH (FOR LP3813-LK3832)</p> 		<p>EKKB.130</p> 		<p>EKKB.427.5.CH (FOR LK3963)</p> 

ALL PISTON RINGS ARE AVAILABLE IN OVERSIZE ORDER RING SETS USING THIS RULE : (e.g. EK---.---.RP.STD = Standard size item.)
 e.g. EK---.---.RP.010= .010 oversize item./e.g. EK---.---.RP.020= .020 oversize item./e.g. EK---.---.RP.030= .030 oversize item./e.g. EK---.---.RP.040= .040 oversize item.

COMPRESSORS

KNORR SINGLE CYLINDER COMPRESSORS

Alternative Part No



LK3501
LK3509
LK3510

EKKB.105



Alternative Part No



LK3833

EKKB.103.33.CH



Alternative Part No



LK3869

EKKB.114



EKKB.114.CH



EKKB.103.RP.STD



Alternative Part No



LK3930 LK3966
LK3940 LK3982
LK3965 LK3986

EKKB.94.CR
(FOR LK18 XX & LP18 XX)



EKKB.100.BU



EKKB.92.RP.STD
(BOX CONTAINS TWO PISTONS AND RINGSET)



EKKB.95.CR
(FOR LK3965)



EKKB.99



EKKB.99.CP



EKKB.99.CHO



Alternative Part No



LK3821
LK3842

EKKB.92.RP.STD
(BOX CONTAINS TWO PISTONS AND RINGSET)



EKKB.102



EKKB.102.CB



KNORR SINGLE CYLINDER COMPRESSORS

<p>Alternative Part No</p>  <p>LK3840 LK3846 LK3859 LK3857</p> <p>LK3841 LK3871 LK3875</p>	<p>EKKB.100.19</p> 	<p>EKKB.103</p> 	<p>EKKB.103.72</p> 	
	<p>EKKB.103.75</p> 	<p>EKKB.103.89.CH FOR LK3859</p> 	<p>EKKB.103.9</p> 	
	<p>EKKB.103.CHO</p> 	<p>EKKB.103.G</p> 	<p>EKKB.103.GB</p> 	
	<p>EKKB.103.RP.STD</p> 			
	<p>Alternative Part No</p>  <p>LK8901 LP3997 LK3401</p>	<p>EKKB.106</p> 	<p>EKKB.106.CH</p> 	<p>EKKB.106.CP</p> 
	<p>EKKB.9.2G.BU</p> 	<p>EKKB.106.CK</p> 	<p>EKKB.104.RP.STD</p> 	
	<p>Alternative Part No</p>  <p>LK3994 LP3974 LP3977 LP3970</p>	<p>EKKB.110</p> 	<p>EKKB.110.CH (For LP3974 Only)</p> 	<p>EKKB.110.CP (For LP3974 Only)</p> 
	<p>EKKB.9.2G.BU</p> 	<p>EKKB.104.RP.STD</p> 		

For the COMPLETE Valve Plate Assy for LK3994 & LP3977 please use: EKKB.100.4 & the Gaskets in EKKB.110

ALL PISTON RINGS ARE AVAILABLE IN OVERSIZE ORDER RING SETS USING THIS RULE : (e.g. EK--.--.RP.STD = Standard size item.)
e.g. EK--.--.RP.010= .010 oversize item./e.g. EK--.--.RP.020= .020 oversize item./e.g. EK--.--.RP.030= .030 oversize item./e.g. EK--.--.RP.040= .040 oversize item.

COMPRESSORS

KNORR SINGLE CYLINDER COMPRESSORS

Alternative Part No		EKKB.91.R.STD	EKKB.91.RP.STD (NOT LP.3843)	EKKB.101
LP3830 LP3832 LP3833 LP3843	LP3857 LP3860 LP3861	EKKB.101.BU 	EKKB.101.CR 	

Alternative Part No		EKKB.9.2G.BU	EKKB.100.4	EKKB.104
LP3980 LP3986		EKKB.104.CH 	EKKB.104.RP.STD 	EKKB.106.CK

Alternative Part No		EKKB.10000	
K157264N00 LS3907		CYLINDER HEAD TO SUIT 06.02.3907// LS3907	K105789K50

KNORR CYLINDER HEAD	
EKKB.308.CH	
Alternatives	1189308
COMPLETE CYLINDER HEAD REPAIR KIT	

WABCO SINGLE CYLINDER COMPRESSORS

<p>Alternative Part No</p>  <p>4123520030 9121160000 9121170000</p>	<p>EKWA.95.R.STD</p> 	<p>EKWA.95.RP.STD</p> 	<p>EKWA.117</p> 
	<p>EKWA.119.CH</p> 		

<p>Alternative Part No</p>  <p>4123520040</p>	<p>EKWA.95.R.STD</p> 	<p>EKWA.95.RP.STD</p> 	<p>EKWA.131.CH</p> 
	<p>EKWA.131</p> 	<p>EKWA.96.CR</p> 	

<p>Alternative Part No</p>  <p>4123520050</p>	<p>EKWA.95.R.STD</p> 	<p>EKWA.95.RP.STD</p> 	<p>EKWA.95.CR</p> 
	<p>EKWA.115</p> 	<p>EKWA.115.CH</p> 	

<p>Alternative Part No</p>  <p>4123520060 4123520140 4123520070 4123520150 4123520090 4123520160 4123520100 4123520170 4123520110 4123520260 4123520130 4123520270</p>	<p>EKWA.95.R.STD</p> 	<p>EKWA.95.RP.STD</p> 	<p>EKWA.95.CR</p> 
	<p>EKWA.114</p> 	<p>EKWA.114.CH</p> 	

ALL PISTON RINGS ARE AVAILABLE IN OVERSIZE ORDER RING SETS USING THIS RULE : (e.g. EK--.--RP.STD = Standard size item.)
e.g. EK--.--RP.010= .010 oversize item./e.g. EK--.--RP.020= .020 oversize item./e.g. EK--.--RP.030= .030 oversize item./e.g. EK--.--RP.040= .040 oversize item.

COMPRESSORS

WABCO SINGLE CYLINDER COMPRESSORS

Alternative Part No



4123520080
4123520200

EKWA.124.CH



EKWA.95.RP.STD



EKWA.124



Alternative Part No



4123520010
4123520020
4123520250

EKWA.95.R.STD



EKWA.116



EKWA.95.RP.STD



EKWA.116.CH



EKWA.95.CR



Alternative Part No



4110345010
4110345310

EKWA.92.A



EKWA.93



EKWA.93.3



EKWA.99.RP.STD



Alternative Part No



4111510000
4111530000

EKWA.103



EKWA.95.RP.STD



EKWA.103.RV



EKWA.96.CR



EKWA.95.R.STD



EKWA.160



WABCO SINGLE CYLINDER COMPRESSORS

<p>Alternative Part No</p>  <p>4111510030 4111510040</p> <p>4111540000 4111540030 4111510090</p>	<p>EKWA.95.R.STD</p> 	<p>EKWA.95.RP.STD</p> 	<p>EKWA.104</p> 
	<p>EKWA.104.CH</p> 	<p>EKWA.160.CH</p> 	<p>CRANK-GEAR5</p> 
<p>Alternative Part No</p>  <p>9115140010 9115148002</p>	<p>EKWA.125.CH</p> 		
<p>Alternative Part No</p>  <p>9111530010 9111539202</p>	<p>EKWA.95.R.STD</p> 	<p>EKWA.95.RP.STD</p> 	<p>EKWA.96.CR</p> 
	<p>EKWA.105</p> 	<p>EKWA.120.CH</p> 	<p>EKWA.160</p> 
<p>Alternative Part No</p>  <p>9111535100 9111535200 9111535300 9111535400</p> <p>9111539360 9111539350 9111535330</p>	<p>EKWA.120</p> 	<p>Alternative Part No</p>  <p>9110047250 9110048960</p>	<p>EKWA.122</p> 

COMPRESSORS

ALL PISTON RINGS ARE AVAILABLE IN OVERSIZE ORDER RING SETS USING THIS RULE : (e.g. EK--.--RP.STD = Standard size item.)
e.g. EK--.--RP.010= .010 oversize item./e.g. EK--.--RP.020= .020 oversize item./e.g. EK--.--RP.030= .030 oversize item./e.g. EK--.--RP.040= .040 oversize item.

WABCO SINGLE CYLINDER COMPRESSORS

Alternative Part No



9111545130
9111545150
9111545160

EKWA.109



EKWA.121.CH



Alternative Part No



9111450500
9111450600

9111455000
9111455600

EKWA.101



Alternative Part No



4111410010
4111410000
4111410020
4111410050
4111410100

4111415000
4111415010
4111415030
4111415040

EKWA.100



EKWA.100.1



Alternative Part No

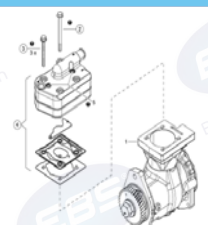

9111545130
9111545150
9111545160

EKWA.121



Alternative Part No



4111428180
4111428160
4111428050
4111428190

4111438050
4111436020
4111438440
4111438450

EKWA.99



EKWA.99.1



EKWA.99.RP.STD



EKWA.99.R.STD



Alternative Part No



9122100000

EKWA.126.1



EKWA.126.CH



KNORR TWIN CYLINDER COMPRESSORS



Alternative Part No

- KZ396/2
- KZ433/1
- KZ996/1
- KZ996/2
- KZ1228/1

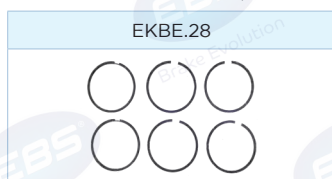
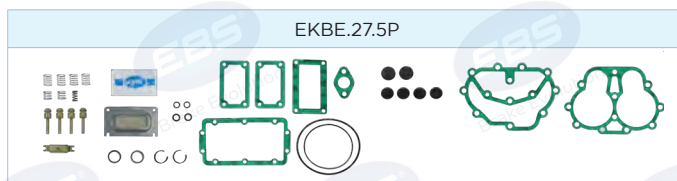

Repair Kits as above except

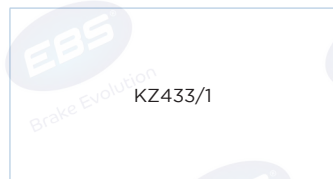

KZ433/1



KZ642/1



KZ996/1





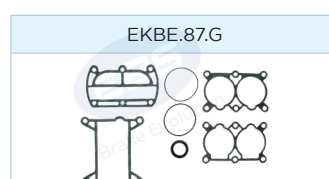
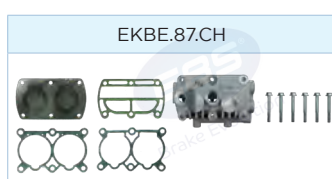







KZ1087/4





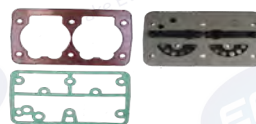
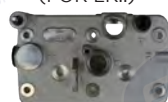





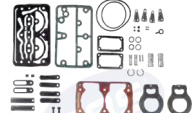



ALL PISTON RINGS ARE AVAILABLE IN OVERSIZE ORDER RING SETS USING THIS RULE : (e.g. EK-...-...-RP.STD = Standard size item.)
 e.g. EK-...-...-RP.010= .010 oversize item./e.g. EK-...-...-RP.020= .020 oversize item./e.g. EK-...-...-RP.030= .030 oversize item./e.g. EK-...-...-RP.040= .040 oversize item.

COMPRESSORS

KNORR TWIN CYLINDER COMPRESSORS

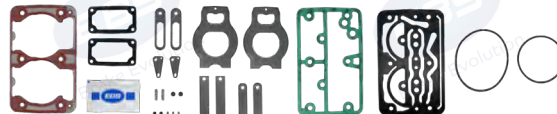
<p>Alternative Part No</p> 	<p>EKKB.9.2F.CR</p> 		<p>EKKB.9.2G</p> 		<p>EKKB.9.2G.CH (FOR LK4920, LP4985)</p> 	
	<p>LK4918 LK4919 LK4920 LK4921</p>	<p>LK4922 LP4985 LP4992</p>	<p>EKKB.9.2G.CR (FOR LK4921/LK4922)</p> 		<p>EKKB.9.2G.BU</p> 	<p>EKKB.9.3G.CH To suit LK4918</p> 
<p>EKKB.122.2 (FOR LK4921)</p> 		<p>EKKB.9.2G.CP</p> 		<p>EKKB.130.5 (FOR LK..)</p> 		
<p>EKKB.130.6 (FOR LP..)</p> 		<p>SEKKB.9.2F</p> 				<p>EKKB.92.R.STD</p> 

<p>Alternative Part No</p> 	<p>EKKB.9.2F</p> 		<p>EKKB.9.2F.CP</p> 		<p>EKKB.9.2F.CH</p> 	
	<p>LK4941 LP4965 LP4930 LP4934 LP4938 LP4949 LP4957 LP4960</p>	<p>LP4961 LP4963 LP4964 LP4966 LP4967 LP4968 LP4974</p>	<p>EKKB.130.4 (FOR LK4941/LP4965/LP4964/ LP4966)</p> 		<p>EKKB.130.3 (FOR LP4930/LP4974)</p> 	
<p>EKKB.130.7 (FOR LP4963)</p> 		<p>EKKB.130.9 (FOR LP4938)</p> 		<p>EKKB.9.2F.CR</p> 		
<p>EKKB.9.2G.BU</p> 		<p>EKKB.92.RP.STD (Box contains TWO Pistons & the Ring Set)</p> 		<p>EKKB.92.R.STD</p> 		
<p>SEKKB.9.2F</p> 				<p>EKKB.9.2F.GS</p> 		

KNORR TWIN CYLINDER COMPRESSORS

<p>Alternative Part No</p> 	<p>EKKB.9.2C</p> 		<p>EKKB.9.2C.CP</p> 		<p>EKKB.92 (FOR LP4812)</p> 		
	<p>LP4812 LP4813 LP4814 LP4815</p>	<p>LP4844 LP4842 LP4852</p>	<p>EKKB.131.1 (FOR LP4813)</p> 		<p>EKKB.131.2 FOR LP4814/LP4815/LP4844/ LP4852/LP4842)</p> 		<p>EKKB.9.2C.CR</p> 
		<p>EKKB.9.2G.BU</p> 		<p>EKKB.9.RP.STD</p> 		<p>EKKB.9.R.STD</p> 	

<p>Alternative Part No</p> 	<p>EKKB.9.2E</p> 						<p>EKKB.123.1</p> 	
	<p>LP4825</p>	<p>EKKB.9.2E.CP</p> 						<p>EKKB.9.2C.CR</p> 
		<p>EKKB.9.2G.BU</p> 		<p>EKKB.9.RP.STD</p> 		<p>EKKB.9.R.STD</p> 		
		<p>EKKB.120.2</p> 		<p>EKKB.122.1</p> 		<p>EKKB.131.3</p> 		

<p>Alternative Part No</p> 	<p>EKKB.9.2D</p> 		<p>EKKB.9.2D.CP</p> 		<p>EKKB.131.4</p> 	
	<p>LP4823 LP4830 LP4850</p>	<p>EKKB.9.2C.CR</p> 		<p>EKKB.9.RP.STD</p> 		<p>EKKB.9.R.STD</p> 

ALL PISTON RINGS ARE AVAILABLE IN OVERSIZE ORDER RING SETS USING THIS RULE : (e.g. EK--.--.RP.STD = Standard size item.)
 e.g. EK--.--.RP.010= .010 oversize item./e.g. EK--.--.RP.020= .020 oversize item./e.g. EK--.--.RP.030= .030 oversize item./e.g. EK--.--.RP.040= .040 oversize item.

COMPRESSORS

KNORR TWIN CYLINDER COMPRESSORS

Alternative Part No



LK4935	LP4861	1194135
LK4936	LP4857	1194354
LK4937	LP4865	1194421
LK4952	LP4863	1194454
	LP4864	1194487

EKKB.9.2I

EKKB.9.2IA

EKKB.9.2IB

EKKB.9.2IC
(FOR LP4857 / LK4936)

EKKB.9.2IC.CH
(FOR K022263)

EKKB.9.2IF

EKKB.93.RP.STD

EKKB.9.2IE

EKKB.9.2IP.CH

EKKB.9.2I.CH
(1194135)

EKKB.9.2I.CP

EKKB.93.R.STD

Alternative Part No



LP4827
LP4845
LP4851
LP4855

EKKB.9.2G.BU

EKKB.9.2H

EKKB.9.2H.CP

EKKB.9.2H.CH

EKKB.9.2H.CR

EKKB.91.R.STD

EKKB.91.RP.STD

EKKB.131.6

EKKB.131.7

KNORR TWIN CYLINDER COMPRESSORS

COMPRESSORS

Alternative Part No



LP4871

EKKB.9.2ID

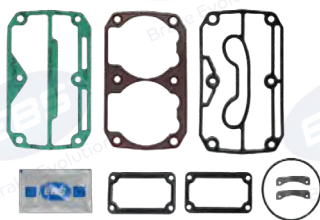

Alternative Part No



LK4911,
LK4931
LK4932
LK4939

EKKB.9.2L



EKKB.9.2L.CH
CYLINDER HEAD



EKKB.9.2L.CP
VALVE PLATE&GASKETS



EKKB.9.2L.PB
PISTON 7 BARREL



EKKB.92.RP.STD
(BOX CONTAINS TWO PISTONS AND RINGSET)



EKKB.9.2L.GB
GASKET & BOLTS



Alternative Part No



LK4928
LK4960

EKKB.9.2G.BU



EKKB.9.2N



EKKB.9.2N.CH



EKKB.9.2N.CP



EKKB.104.RP.STD



Alternative Part No



LK4934

EKKB.9.2G.BU



EKKB.104.RP



EKKB.108



EKKB.108.CH









EKKB.108.CP

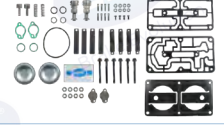

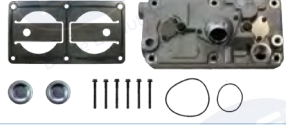
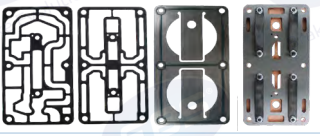
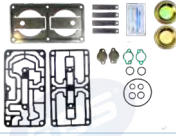
ALL PISTON RINGS ARE AVAILABLE IN OVERSIZE ORDER RING SETS USING THIS RULE : (e.g. EK--.--RP.STD = Standard size item.)
e.g. EK--.--RP.010= .010 oversize item./e.g. EK--.--RP.020= .020 oversize item./e.g. EK--.--RP.030= .030 oversize item./e.g. EK--.--RP.040= .040 oversize item.

KNORR TWIN CYLINDER COMPRESSORS

<p>Alternative Part No</p> 	<p>EKKB.9.2M</p> 		<p>EKKB.9.2G.BU</p> 	<p>EKKB.9.2M.CH</p> 	
	<p>LK4945 LK4966</p>	<p>LK4968 LK4972</p>	<p>EKKB.9.2M.CP</p> 	<p>EKKB.9.2R</p> 	<p>EKKB.9.2R.ESS</p> <p>FOR LK4972</p> 
		<p>EKKB.93.R.STD</p> 	<p>EKKB.93.RP.STD</p> 		

<p>Alternative Part No</p> 	<p>EKKB.9.2G.BU</p> 	<p>EKKB.93.R.STD</p> 	<p>EKKB.93.RP.STD</p> 	<p>EKKB.109</p> 
	<p>LK4951</p>	<p>EKKB.109.C</p> 	<p>EKKB.109.CH</p> 	<p>EKKB.109.CP</p> 

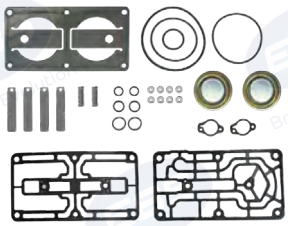
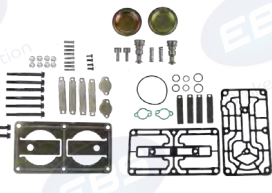
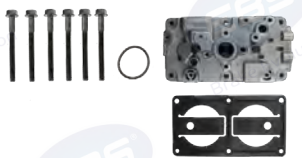
<p>Alternative Part No</p> 	<p>EKKB.109</p> 		<p>EKKB.109.C</p> 	<p>EKKB.109.CH</p> 
	<p>LK4970, LK4949 K038653N00</p>			

KNORR TWIN CYLINDER COMPRESSORS

Alternative Part No



LK4930
LK4944
LK4954

EKKB.9.2K



EKKB.9.2K.CH
(For LP4944/LP4954)



EKKB.9.3K.CH
(For LK4930)



EKKB.104.RP.STD



EKKB.9.2G.BU



Alternative Part No



LK8907 K162503N00

EKKB.104.RP.STD



EKKB.10001
CYLINDER HEAD



EKKB.10002
REPAIR KIT (VALVE PLATE)



EKKB.10003
REPAIR KIT (VALVES & GASKETS)



Alternative Part No



LP4832 1013383000
LP4940 1013393000
LP4942
LP4943
LP4944

EKPD.8



EKPD.8.R.STD



EKPD.8.RP.STD
(For LP4943/1013383000/1013393000)



EKKB.70.R.STD
(For LP4832/LP4840/LP4842/LP4944)



EKKB.70.RP.STD
(For LP4832/LP4840/LP4842/LP4944)



ALL PISTON RINGS ARE AVAILABLE IN OVERSIZE ORDER RING SETS USING THIS RULE : (e.g. EK--.--RP.STD = Standard size item.)
e.g. EK--.--RP.010= .010 oversize item./e.g. EK--.--RP.020= .020 oversize item./e.g. EK--.--RP.030= .030 oversize item./e.g. EK--.--RP.040= .040 oversize item.

COMPRESSIONS

WABCO TWIN CYLINDER COMPRESSORS

Alternative Part No



4127040000	4127040140
4127040070	4127040150
4127040120	4127040160
4127040130	

EKKB.9.2G.BU



EKWA.95.CR



EKWA.95.R.STD



EKWA.95.RP.STD



EKWA.108.1



EKWA.108.1CH



EKWA.108.BF



Alternative Part No



4127040190

EKWA.109.CH

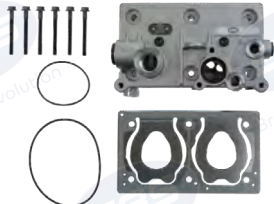

Alternative	4127049372
-------------	------------

Alternative Part No



4127040180
4127040270

EKKB.9.2G.BU



EKWA.95.CR



EKWA.95.R.STD



EKWA.95.RP.STD



EKWA.108.3

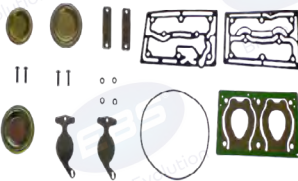

EKWA.108.2





EKWA.108.BF



WABCO TWIN CYLINDER COMPRESSORS

<p>Alternative Part No</p>  <p>4127040010 4127040040 4127040050 4127040080</p>	<p>EKKB.9.2G.BU</p> 	<p>EKWA.95.RP.STD</p> 	<p>EKWA.95.CR</p> 
	<p>EKWA.108</p> 	<p>EKWA.108.CH</p> 	<p>EKWA.140</p> 
	<p>EKWA.108.BF</p> 	<p>EKWA.108.CP</p> 	

<p>Alternative Part No</p>  <p>411553000</p>	<p>EKKB.9.2G.BU</p> 	<p>EKWA.9.7</p> 	<p>EKWA.9.7CH</p> 
	<p>EKWA.95.R.STD</p> 	<p>EKWA.95.RP.STD</p> 	<p>EKWA.96.CR</p> 

<p>Alternative Part No</p>  <p>4115530010 4115530030</p>	<p>EKWA.9.2.CH</p> 	<p>EKKB.9.2G.BU</p> 	<p>EKWA.95.R.STD</p> 
	<p>EKWA.95.RP.STD</p> 	<p>EKWA.96.CR</p> 	<p>EKWA.113</p> 

ALL PISTON RINGS ARE AVAILABLE IN OVERSIZE ORDER RING SETS USING THIS RULE : (e.g. EK--.--RP.STD = Standard size item.)
e.g. EK--.--RP.010= .010 oversize item./e.g. EK--.--RP.020= .020 oversize item./e.g. EK--.--RP.030= .030 oversize item./e.g. EK--.--RP.040= .040 oversize item.

COMPRESSORS

WABCO TWIN CYLINDER COMPRESSORS

Alternative Part No	Alternative Part No	Alternative Part No
		
4124420000	4124420010	9115045060



Alternative Part No

4126360000 4126360010 4126360030

9115530000 9115530010 9115530030 9115530070

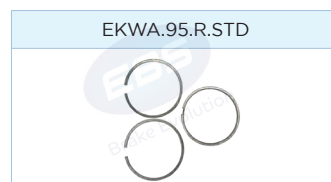
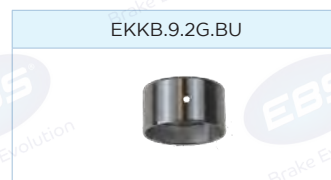

WABCO TWIN CYLINDER COMPRESSORS

Alternative Part No



9111555140

EKWA.111



Alternative Part No



9115010100
9115010110
9115010160
9115010550

9115010560
9115010590
9115010620

Alternative Part No



9115010600
9115010610

EKWA.9.C



EKWA.9.D



EKWA.95.R.STD



EKWA.95.RP.STD



EKWA.108.BU



Alternative Part No



9115011510
9115051500
9115051510

EKWA.95.C



EKWA.95.CR



EKWA.95.R.STD



EKWA.95.RP.STD



EKWA.108.BU



EKWA.123.14



ALL PISTON RINGS ARE AVAILABLE IN OVERSIZE ORDER RING SETS USING THIS RULE : (e.g. EK--.--RP.STD = Standard size item.)
e.g. EK--.--RP.010= .010 oversize item./e.g. EK--.--RP.020= .020 oversize item./e.g. EK--.--RP.030= .030 oversize item./e.g. EK--.--RP.040= .040 oversize item.

COMPRESSORS

WABCO TWIN CYLINDER COMPRESSORS

Alternative Part No



9115040520

EKKB.9.2G.BU



EKWA.90.C



EKWA.90.RP.STD



EKWA.90.CR



EKWA.90.CP



EKWA.131.7



Alternative Part No



9115045000
9115045010
9115045020
9115045030

EKWA.9.E



EKWA.95.CR



EKWA.9.E.CH



EKWA.95.RP.STD



EKWA.90.RP.STD



Alternative Part No



9115040560
9115040600

EKWA.9.F



EKWA.95.CR



EKWA.9.F.CH



EKWA.95.R.STD



EKKB.9.2G.BU



EKWA.95.RP.STD



Alternative Part No



9115060540

EKWA.9.G

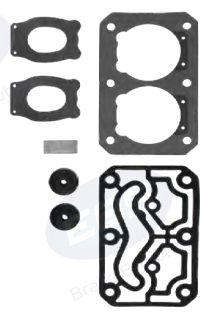

WABCO TWIN CYLINDER COMPRESSORS

Alternative Part No



9115065000
9115065040

EKWA.9.K

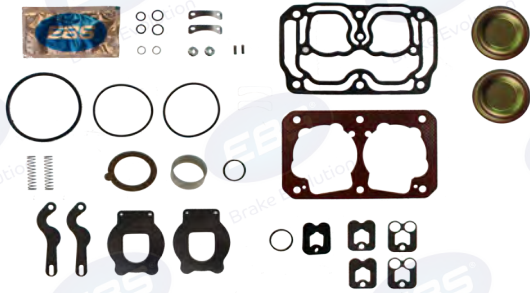

Alternative Part No



9115150010 9115150080
9115150030 9115150090

EKWA.9.11



Alternative 9115159232

EKWA.9.11.CH

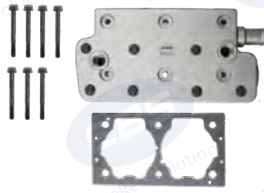

Alternative 9115159212

Alternative Part No



9115160100

EKWA.9.10



EKWA.9.10.CH



EKWA.90.RP.STD



Alternative Part No



9115532000

Alternative Part No



9115532030

EKWA.9.L



EKWA.90.CR



EKWA.9.L.CH



EKWA.90.RP.STD



ALL PISTON RINGS ARE AVAILABLE IN OVERSIZE ORDER RING SETS USING THIS RULE : (e.g. EK--.--RP.STD = Standard size item.)
e.g. EK--.--RP.010= .010 oversize item./e.g. EK--.--RP.020= .020 oversize item./e.g. EK--.--RP.030= .030 oversize item./e.g. EK--.--RP.040= .040 oversize item.

COMPRESSORS

WABCO TWIN CYLINDER COMPRESSORS

Alternative Part No



9115530020	9115531030
9115531000	9115531040
9115531010	9115531050

EKWA.9.H



EKWA.9.H.CH



EKWA.95.CR



EKWA.90.RP.STD



Alternative Part No



9125100010

EKKB.9.2G.BU



EKWA.96.CR



EKWA.95.R.STD



EKWA.95.RP.STD



EKWA.123



EKWA.123.CH



Alternative Part No



9125101000	9125101030
9125101010	9125101040
9125101020	

EKWA.9.5



SEKWA.9.5

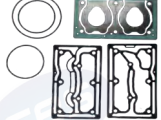

EKWA.9.5.CH



EKWA.95.CR



C1001



EKWA.95.R.STD



EKWA.95.RP.STD



Alternative Part No



9125102000







EKWA.9.3.CH



EKWA.9.3.CHO



WABCO TWIN CYLINDER COMPRESSORS

<p>Alternative Part No</p> 	<p>EKKB.9.2G.BU</p> 	<p>EKWA.96.CR</p> 	<p>EKWA.9.4</p> 	<p>SEKWA.9.4</p> 
	<p>9125120010 9125120060 9125140010</p>	<p>9125140030 9125140040</p>	<p>EKWA.9.4.CHP</p> 	<p>EKWA.95.RP.STD</p> 

<p>Alternative Part No</p> 	<p>EKWA.9.14</p> 	<p>EKWA.9.14.AU</p> 
	<p>9125120330</p>	<p>EKWA.9.14.C</p> 

<p>Alternative Part No</p> 	<p>EKWA.9.8</p> 	<p>EKWA.9.8.CH</p> 	<p>C1002</p> 	
	<p>9125180000 9125180010 9125180020</p>	<p>9125180030 9125180040</p>	<p>EKWA.95.RP.STD</p> 	<p>EKWA.95.R.STD</p> 

ALL PISTON RINGS ARE AVAILABLE IN OVERSIZE ORDER SETS USING THIS RULE : (e.g. EK--.--.RP.STD = Standard size item.)
 e.g. EK--.--.RP.010= .010 oversize item./e.g. EK--.--.RP.020= .020 oversize item./e.g. EK--.--.RP.030= .030 oversize item./e.g. EK--.--.RP.040= .040 oversize item.

COMPRESSIONS

WABCO TWIN CYLINDER COMPRESSORS

Alternative Part No



9125180050
9125189252

EKWA.9.12.CH

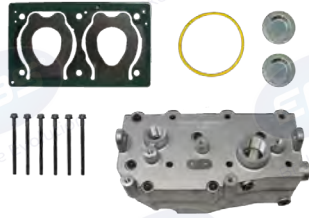

Alternative Part No



9125181000
9125181010
9125181020
9125181030
9125181040
9125182000
9125182010

9125182020
9125182030
9125182040
9125182050
9125182060
9125182070

EKWA.9.9.CH



EKWA.9.9.CP

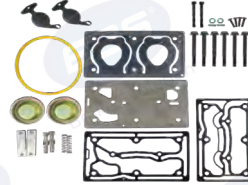

EKWA.95.R.STD



EKWA.95.RP.STD



C1001



Alternative Part No



9125220000
9125220010
9125220020

EKWA.10006

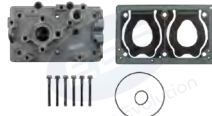

EKWA.10007

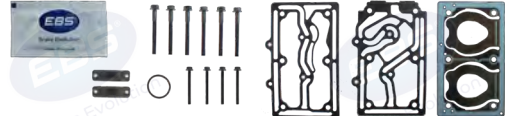

TO SUIT CYLINDER HEAD
9125229242

MAGNETI MARELLI SINGLE CYLINDER COMPRESSORS

Alternative Part No



ACX67A ACX67AA ACX67AAG ACX67AX	ACX67AZ ACX67AZG ACX67BA ACX67BAG
--	--

EKMM.14



EKMM.14.1



EKMM.90.R.STD



EKMM.90.CR



EKMM.90.RP.STD



Alternative Part No



ACX68D

EKMM.16



Alternative Part No



ACX75ZB ACX75ZF ACX75ZG	ACX75ZFG ACX75ZM ACX75ZMG
-------------------------------	---------------------------------

EKMM.12



EKMM.12.1



EKMM.12.RP.STD



EKMM.12.CHO



EKMM.90.CR



Alternative Part No



ACX83A ACX83B	ACX83AS ACX83D
------------------	-------------------

EKMM.90



EKMM.90.CH



EKMM.91.RP.STD



EKMM.92.RP.STD



EKMM.91.R.STD



ALL PISTON RINGS ARE AVAILABLE IN OVERSIZE ORDER RING SETS USING THIS RULE : (e.g. EK--.--RP.STD = Standard size item.)
 e.g. EK--.--RP.010= .010 oversize item./e.g. EK--.--RP.020= .020 oversize item./e.g. EK--.--RP.030= .030 oversize item./e.g. EK--.--RP.040= .040 oversize item.

BENDIX TUFLO COMPRESSORS

Alternative Part No

TUFLO 400: 280722 280728

EKBE.1

EKBE.3



Alternative Part No

TUFLO 500: 280737 271721
TUFLO 700: 289257

EKBE.11.RP.STD

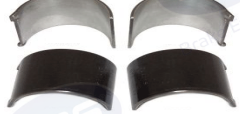

EKBE.15

EKBE.12

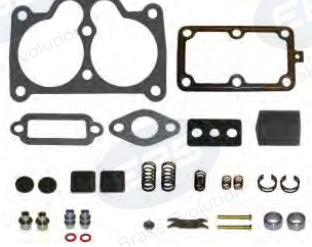

EKBE.13

Alternative Part No

TUFLO 501: 286104 285977
286546 287034

EKBE.15.3

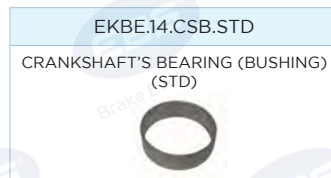
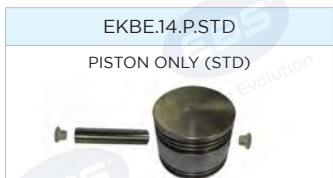
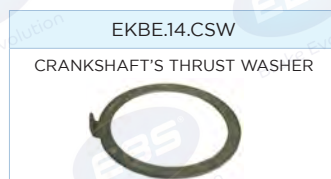
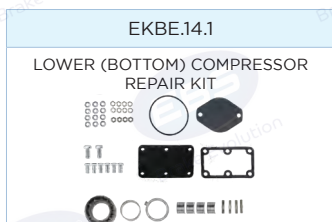
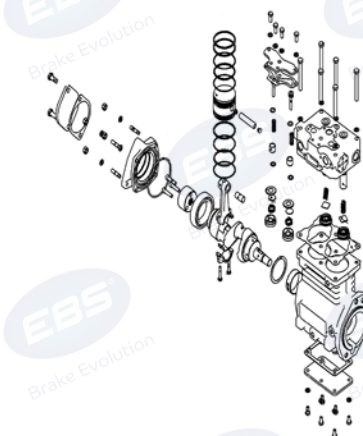
EKBE.19.RP.STD

BENDIX TUFLO 750 COMPRESSORS



COMPRESSORS

ALL PISTON RINGS ARE AVAILABLE IN OVERSIZE ORDER RING SETS USING THIS RULE : (e.g. EK--.--.RP.STD = Standard size item.)
e.g. EK--.--.RP.010= .010 oversize item./e.g. EK--.--.RP.020= .020 oversize item./e.g. EK--.--.RP.030= .030 oversize item./e.g. EK--.--.RP.040= .040 oversize item.

CLAYTON DEWANDRE COMPRESSORS

Alternative Part No	Alternative Part No	Alternative Part No
PCGA1046	PCGA1059	PCGA1072

EKCD.3.4 	EKCD.3.1.CH 	EKCD.3.L 	EKCD.3.CP
--------------	-----------------	--------------	---------------

RENAULT MAJOR / MAGNUM COMPRESSORS

EKPP.9.1.C 	EKPP.9.1 	EKPP.9.1.CB 	EKPP.9.1.CH 	EKPP.9.RP
EKPP.9.C 	EKPP.9 	EKPP.9.CH 	EKPP.9.CR 	EKPP.9.CS
	EKPP.9.CB 			

VARGA COMPRESSORS

Alternative Part No 	EKVA.1 	EKVA.6 	EKVA.11
EL1600			

MAN COMPRESSORS

Alt. Part No 	Alt. Part No 	Alt. Part No 	Alt. Part No 	Alt. Part No 	Alt. Part No 
51540007057	51540007059	51540007063	51540007073	51540007027 51540007079 51540007086 51540007121	51540007131 51540007135 51541006001

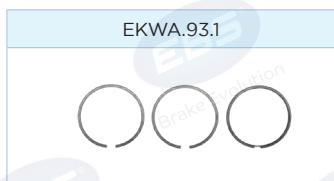
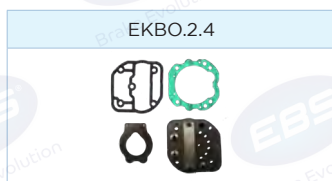
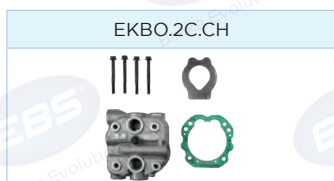

ALL PISTON RINGS ARE AVAILABLE IN OVERSIZE ORDER RING SETS USING THIS RULE : (e.g. EK--.--RP.STD = Standard size item.)
e.g. EK--.--RP.010= .010 oversize item./e.g. EK--.--RP.020= .020 oversize item./e.g. EK--.--RP.030= .030 oversize item./e.g. EK--.--RP.040= .040 oversize item.

COMPRESSIONS

MAN COMPRESSORS

	Alternative Part No	Alternative Part No	Alternative Part No
TYPE 1			
	51540007058	51540007058	51540007058
	Application	Application	Application
	MAN 19.260/ 19.360/ 19.361/ 1919/ 1922 MERCEDES OM402/ 403/ 407 MERCEDES 4471301815 4751300115	MAN 1919 / 1922 MERCEDES MB407 MERCEDES 4071300115	MAN MERCEDES

EKBO.2.A

To Suit: **Type 3**

EKBO.2.C

To Suit: **Type 1**

EKBO.2.C.DIM

To Suit: **Type 2**

EKBO.2.4

To Suit: **Type 1**

EKBO.147

To Suit: **Type 3**

EKKB.100.1

To Suit: **Type 2**

EKBO.2.C.CH

To Suit: **Type 1**

EKBO.2.A.CH

To Suit: **Type 3**

EKKB.427.5.CH

To Suit: **Type 2**

EKWA.93.1

EKWA.97.A

EKWA.97.CR





EKWA.97.CS

EKWA.97.RP.STD

EKBO.2.BR

EKBO.2.BU

MAN COMPRESSORS

TYPE 1	Alternative Part No	TYPE 2	Alternative Part No	TYPE 3	Alternative Part No	TYPE 4	Alternative Part No
							
	51540007074		51540007074		51540007074		51540007074
	Application		Application		Application		Application
MAN - MERCEDES		MAN - MERCEDES		MAN - MERCEDES		MAN - MERCEDES	

EKBO.2C To Suit: Type 3 	EKBO.2C.DIM To Suit: Type 2 	EKBO.2.4 To Suit: Type 1 Type 3 	EKBO.2.19 To Suit: Type 2 
EKBO.2.16 To Suit: Type 4 	EKBO.2C.CH To Suit: Type 1 Type 3 	EKBO.2.16.CH To Suit: Type 4 	EKBO.2.19.CH To Suit: Type 2 
EKBO.146 To Suit: Type 4 	EKBO.148 To Suit: Type 2 	EKBO.149 To Suit: Type 2 	EKWA.93.1 
EKWA.97.W 	EKWA.97.CR 	EKWA.97.CS 	EKWA.97.RP.STD 
EKBO.2.BR 	EKBO.2.BU 		

COMPRESSORS

ALL PISTON RINGS ARE AVAILABLE IN OVERSIZE ORDER RING SETS USING THIS RULE : (e.g. EK--.--.RP.STD = Standard size item.)
e.g. EK--.--.RP.010= .010 oversize item./e.g. EK--.--.RP.020= .020 oversize item./e.g. EK--.--.RP.030= .030 oversize item./e.g. EK--.--.RP.040= .040 oversize item.

MAN COMPRESSORS

Alternative Part No	Alternative Part No
	
51540007178	51541006003 51541007010 51541006007 51541007028 51541006009 51541007066

EKBO.2.A



To Suit: 51540007178

EKWA.102



To Suit: 51541006003-7066

EKBO.147



To Suit: 51540007178

EKWA.102.CH



To Suit: 51541006003-7066

EKBO.2.A.CH



To Suit: 51540007178

EKWA.93.1



EKWA.97.RP.STD



EKWA.97.CS



To Suit: 51540007178

EKWA.97.CR



EKBO.2.BR



To Suit: 51541006003-7066

EKBO.2.BU



To Suit: 51541006003-7066

Alternative Part No



51541007033

EKWA.97.CS



EKWA.97.CR



EKWA.118



EKWA.118.CH



EKWA.118.RP.STD



EKWA.118.CB



MAN COMPRESSORS

Alternative Part No	Alternative Part No	Alternative Part No	
			
51541006005 51541007003	51541007249	51541006011 51541006013 51541006015	51541007025 51541007179

EKBO.2.BU To Suit: 51541006005 51541007003 51541007249 	EKWA.97.CS To Suit: 51541006011 51541006013 51541006015 51541007025 51541007179 	EKWA.118 	EKWA.118.CB 
EKWA.118.CH 	EKWA.118.RP.STD 	EKWA.118.CR 	

MERCEDES COMPRESSORS

Alternative Part No  4471302215 4471303315 4471302015	EKBO.2.7 	EKBO.2.8 	EKBO.218  EKWA.118.RP.STD 
Alternative Part No  4571305015 9125103000 9125103030	EKWA.9.6 	EKWA.9.6.CH1  C1001 	EKWA.9.6.CH2  EKWA.95.RP.STD 

ALL PISTON RINGS ARE AVAILABLE IN OVERSIZE ORDER RING SETS USING THIS RULE : (e.g. EK--.--.RP.STD = Standard size item.)
e.g. EK--.--.RP.010= .010 oversize item./e.g. EK--.--.RP.020= .020 oversize item./e.g. EK--.--.RP.030= .030 oversize item./e.g. EK--.--.RP.040= .040 oversize item.

COMPRESSIONS

MERCEDES COMPRESSORS

Alternative Part No



4721300015
4721300815
4721301515

EKBO.2.18



EKBO.2.18.CP



EKBO.2.18.CH



Alternative Part No



ACTROS OM501/502
ACTROS OM501/502 (V6N - V8N)

EKBO.2.12A



EKBO.2.12



EKBO.2.12CP



EKBO.2.9



EKBO.2.9CP



EKBO.129



EKWA.118.RP.STD



EKBO.130



EKBO.150



EKKB.428.9.CH



Alternative Part No



4471302815

EKBO.2.15



EKBO.2.15CP



EKBO.2.15.CS



EKWA.118.RP.STD



EKBO.131



MERCEDES COMPRESSORS

<p>Alternative Part No</p>  <p>5411303619</p>	<p>EKBO.2.17</p> 	<p>EKBO.2.17.CP</p> 	<p>EKBO.2.17.CR</p>  <p>EKBO.132</p> 
--	--	--	---

<p>Alternative Part No</p>  <p>3521300615 3521300215</p>	<p>EKWA.96.A</p>  <p>EKWA.96.CH</p> 
---	---

MERCEDES COMPRESSORS - OTHERS

<p>EKBO.2.9.W</p>   <p>To suit 5411300108</p>	<p>EKBO.2.17.W</p>   <p>To suit 5411300108</p>
--	---

ALL PISTON RINGS ARE AVAILABLE IN OVERSIZE ORDER RING SETS USING THIS RULE : (e.g. EK--.--.RP.STD = Standard size item.)
 e.g. EK--.--.RP.010= .010 oversize item./e.g. EK--.--.RP.020= .020 oversize item./e.g. EK--.--.RP.030= .030 oversize item./e.g. EK--.--.RP.040= .040 oversize item.

COMPRESSORS

VOITH COMPRESSORS

Alternative Part No



14900006015 / 14900077203
 14900085312 / 14900095502
 14900107503 / 14900109402
 14900113202 / 14900128010
 14900140911 / 14900148802
 14900172710

EKVO.1



EKVO.2

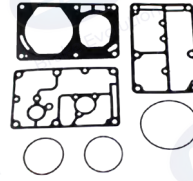

EKVO.60.C



EKVO.60.RP.STD



EKVO.92.C



EKVO.92.RP.STD



Alternative Part No



14900127710
 14900127711

EKVO.7



EKVO.7.2



Alternative 14900127711

EKVO.7.60.C
 CYLINDER LINER 60mm



Alternative 14900127711

EKVO.7.92.C
 CYLINDER LINER 92mm



Alternative 14900127711

EKVO.7.CH



Alternative 14900127710

EKVO.60.RP.STD



EKVO.92.RP.STD



Alternative Part No



LP700

EKVO.10000
 REPAIR KIT
 (VALVES & GASKETS)

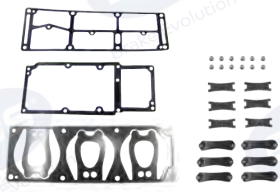

MISC. FITTING ACCESSORIES

<p>CRANK-GEAR1</p>  <p>2022257</p>	<p>CRANK-GEAR2</p>  <p>2022259</p>	<p>CRANK-GEAR3</p>  <p>4071300030</p>	<p>CRANK-GEAR4</p>  <p>4295536</p>
<p>CRANK-GEAR5</p>  <p>4111510040</p>	<p>CRANK-GEAR6</p>  <p>LP4825, 9115051510</p>	<p>CRANK-GEAR7</p>  <p>LP4845</p>	<p>CRANK-GEAR8</p>  <p>LP4851, 4124420000</p>
<p>CRANK-GEAR9</p>  <p>51542100108</p>	<p>CRANK-GEAR10</p>  <p>LK4941</p>	<p>CRANK-GEAR11</p>  <p>4571320905</p>	<p>CRANK-GEAR12</p>  <p>9061320305</p>
<p>CRANK-GEAR13</p>  <p>1205112</p>	<p>CRANK-GEAR14</p>  <p>1641625</p>	<p>CRANK-NUT 1</p>  <p>RIGHT HAND M18 x 1.5</p>	<p>CRANK-NUT 2</p>  <p>RIGHT HAND M20 x 1.5</p>
<p>CRANK-NUT 3</p>  <p>LEFT HAND M20 x 1.5</p>	<p>CRANK-NUT 4</p>  <p>LEFT HAND M18 x 1.5</p>	<p>FLANGEGASKET-1</p>  <p>LK3850</p>	<p>FLANGEGASKET-2</p>  <p>9111450600 9111455600</p>
<p>FLANGESEAL-1</p>  <p>LK3833 LK3875</p> <p>LP4845 LP4944</p>	<p>FLANGESEAL-2</p>  <p>LK4918 LK4941 LP4814 LP4815</p> <p>LP4825 LP4964 9115051500</p>	<p>FLANGESEAL-3</p>  <p>LK4921</p>	<p>FLANGESEAL-4</p>  <p>LP4857 LP4851 LP4974 LP4992</p> <p>4127040080 9115040520 9125182060</p>

COMPRESSORS

ALL PISTON RINGS ARE AVAILABLE IN OVERSIZE ORDER RING SETS USING THIS RULE : (e.g. EK--.--.RP.STD = Standard size item.)
e.g. EK--.--.RP.010= .010 oversize item./e.g. EK--.--.RP.020= .020 oversize item./e.g. EK--.--.RP.030= .030 oversize item./e.g. EK--.--.RP.040= .040 oversize item.

MISC. FITTING ACCESSORIES

<p>FLANGESEAL-5</p> <p>4111510040 9121170000</p>	<p>FLANGESEAL-6</p> <p>4111510090 4115530030</p>	<p>FLANGESEAL-7</p> <p>4123520030 9121160000</p>	<p>FLANGESEAL-8</p> <p>9115045060</p>
<p>FLANGESEAL-9</p> <p>9125140090</p>	<p>FLANGESEAL-10</p> <p>4123520030 9121160000</p>	<p>FLANGESEAL-11</p> <p>LK3966</p>	<p>FLANGESEAL-12</p> <p>LK3869</p>
<p>FLANGESEAL-13</p> <p>LK4949</p>	<p>FLANGESEAL-14</p> <p>9125180040 9125180050 9125181030</p>	<p>FLANGESEAL-15</p> <p>4123520250 4127040140</p>	<p>FLANGESEAL-16</p> <p>4127040190</p>

HYDROVANE COMPRESSOR



T02	
Hydrovane Compact Vane Compressor	
FITS WRIGHTBUS	
Repair Kit	---

Benefits

Lightweight and compact design - saving fuel and maximising passenger space.



















Extremely quiet and vibration free operation - providing a noise-free passenger environment.

Fully integrated module - saving up to 50% of the weight of conventional designs.

Water-cooled design requires no ventilation- enabling easy installation where space is at a premium.

Variable speed inverter drive technology - Integrating with customer system.

EBS NEW & REMANUFACTURED COMPRESSORS - KNORR BREMSE

06.02.1314		06.02.1506		06.02.1527		06.02.1802	
							
Alternative Part No	LK1314	Alternative Part No	LK1506	Alternative Part No	LK1527	Alternative Part No	LK1802 180864
06.02.1973		R06.02.1567		06.02.1813		R06.02.1813	
							
Alternative Part No	LK4973 K168097N00	Alternative Part No	LK1567	Alternative Part No	LK1813	Alternative Part No	LK1814
R06.02.1833		R06.02.1840		06.02.1841		R06.02.1841	
							
Alternative Part No	LK3833	Alternative Part No	LK3840	Alternative Part No	LK3841	Alternative Part No	LK3850
R06.02.1859		R06.02.1869		06.02.1875		R06.02.1875	
							
Alternative Part No	LK3859	Alternative Part No	LK3869	Alternative Part No	K008457X00 LK3875	Alternative Part No	LK3966
06.02.1901		R06.02.1918		R06.02.1920		06.02.1920	
							
Alternative Part No	LK1901	Alternative Part No	LK4918	Alternative Part No	LK4920 K00203200	Alternative Part No	LK4921

ALL PISTON RINGS ARE AVAILABLE IN OVERSIZE ORDER RING SETS USING THIS RULE : (e.g. EK--.--RP.STD = Standard size item.)
e.g. EK--.--RP.010= .010 oversize item./e.g. EK--.--RP.020= .020 oversize item./e.g. EK--.--RP.030= .030 oversize item./e.g. EK--.--RP.040= .040 oversize item.

COMPRESSORS

EBS NEW & REMANUFACTURED COMPRESSORS - KNORR BREMSE

06.02.1927		R06.02.1936		06.02.1937		06.02.1939	
							
Alternative Part No	LK3927	Alternative Part No	LK4936	Alternative Part No	LK4937	Alternative Part No	LK4939 K09587N00
06.02.1941		R06.02.1941		R06.02.1944		06.02.1947	
							
Alternative Part No	LK4941	Alternative Part No	LK4944	Alternative Part No	LK3947 K040432N00	Alternative Part No	LK4951
06.02.1960		06.02.1970		06.02.1980		R06.02.2701	
							
Alternative Part No	LK4960 K089063N00	Alternative Part No	LK4970 K038653N00	Alternative Part No	LK3980	Alternative Part No	LP8701 K015518
06.02.2812		R06.02.2812		06.02.2813		06.02.2814	
							
Alternative Part No	LP4812	Alternative Part No	LP4813	Alternative Part No	LP4814	Alternative Part No	LP4815
06.02.2823		R06.02.2823		R06.02.2825		06.02.2825	
							
Alternative Part No	LP4823	Alternative Part No	LP4825	Alternative Part No	LP1828	Alternative Part No	LP4844

EBS NEW & REMANUFACTURED COMPRESSORS - KNORR BREMSE

06.02.2845	R06.02.2845	06.02.2850		R06.02.2851	06.02.2851	06.02.2855	
							
Alternative Part No	LP4845	Alternative Part No	LP4850	Alternative Part No	LP4851	Alternative Part No	LP4855
06.02.2857		R06.02.2861		R06.02.2863		R06.02.2864	
							
Alternative Part No	LP4857	Alternative Part No	LP4861	Alternative Part No	LP4863	Alternative Part No	LP4864
06.02.2865		R06.02.2871	06.02.2871	06.02.2927		06.02.2934	R06.02.2934
							
Alternative Part No	LP4865	Alternative Part No	LP4871 K035001N00	Alternative Part No	LP3927 176067	Alternative Part No	LP4934
06.02.2940		06.02.2955		06.02.2957	R06.02.2957	06.02.2960	
							
Alternative Part No	LP3940 1114385	Alternative Part No	LP4955	Alternative Part No	LP4957	Alternative Part No	LP4960
06.02.2961	R06.02.2961	06.02.2964	R06.02.2964	06.02.2967	R06.02.2967	R06.02.2970	
							
Alternative Part No	LP4961	Alternative Part No	LP4964	Alternative Part No	LP4967	Alternative Part No	LP3970

ALL PISTON RINGS ARE AVAILABLE IN OVERSIZE ORDER RING SETS USING THIS RULE : (e.g. EK--.--RP.STD = Standard size item.)
 e.g. EK--.--RP.010= .010 oversize item./e.g. EK--.--RP.020= .020 oversize item./e.g. EK--.--RP.030= .030 oversize item./e.g. EK--.--RP.040= .040 oversize item.

COMPRESSORS

EBS NEW & REMANUFACTURED COMPRESSORS - KNORR BREMSE

06.02.2974	R06.02.2974	06.02.2983	06.02.2983	06.02.2985	R06.02.2985	06.02.2992	
							
Alternative Part No	LP4974	Alternative Part No	LP4983	Alternative Part No	LP4985	Alternative Part No	LP4992
06.02.2997	R06.02.2997	06.02.3813		06.02.3907		06.02.10000	
							
Alternative Part No	LP3997	Alternative Part No	LK3813 I94314	Alternative Part No	K157264N00 LS3907	Alternative Part No	LK4975 K171591N00
06.02.10001		06.06.1000		06.06.1001		06.06.1002	
							
Alternative Part No	LK8907 K162503N00	Alternative Part No	KZ1228/1X50	Alternative Part No	KZ396/3X50	Alternative Part No	KZ433/1X50 1186722SP
06.06.1003	R06.06.1003	06.06.1004	R06.06.1004	R06.06.1005		R06.06.1007	
							
Alternative Part No	BR5503	Alternative Part No	KZ996/2X50	Alternative Part No	1194215X50	Alternative Part No	KZ1087/4X50
R06.06.1008		R06.06.1009		R06.06.1010		R06.06.1011	
							
Alternative Part No	KZ1257/3X50	Alternative Part No	101256	Alternative Part No	289924	Alternative Part No	1189497

EBS NEW & REMANUFACTURED COMPRESSORS - KNORR BREMSE

R06.06.1012		R06.06.1013		R06.06.1006	06.06.1014	06.07.1002	
							
Alternative Part No	1189289	Alternative Part No	287631	Alternative Part No	KZ1143/2X50	Alternative Part No	KO07388/ ACX69D

EBS NEW COMPRESSORS - MAN

06.26.1003		06.26.1004		06.26.1006		06.26.1001	
							
Alternative Part No	51541006007	Alternative Part No	51541006015	Alternative Part No	51541007033	Alternative Part No	51540007058

06.26.1007		06.26.1002		06.26.1005	
					
Alternative Part No	51540007064	Alternative Part No	51540007074	Alternative Part No	51541007178

EBS NEW COMPRESSORS - MARELLI

06.07.1000	
	
Alternative Part No	ACX83D

06.07.1001	
	
Alternative Part No	---

EBS NEW COMPRESSORS - VOITH

06.44.7710	
	
Alternative Part No	14900127710

COMPRESSORS

ALL PISTON RINGS ARE AVAILABLE IN OVERSIZE ORDER RING SETS USING THIS RULE : (e.g. EK--.--.RP.STD = Standard size item.)
 e.g. EK--.--.RP.010= .010 oversize item./e.g. EK--.--.RP.020= .020 oversize item./e.g. EK--.--.RP.030= .030 oversize item./e.g. EK--.--.RP.040= .040 oversize item.

EBS NEW & REMANUFACTURED COMPRESSORS - WABCO

R06.01.1000	06.01.1000			R06.01.1001			06.01.1002			06.01.1004	R06.01.1004				
Alternative Part No	4111510000	Alternative Part No	4111410100	Alternative Part No	4111410020	Alternative Part No	4111540040	Alternative Part No	4111540000	Alternative Part No	4111540030				
06.01.1009	R06.01.1009			06.01.1501			06.01.1805			R06.01.2003	06.01.2003				
Alternative Part No	4111510090	Alternative Part No	4110345010	Alternative Part No	4111438050	Alternative Part No	4123520030			Alternative Part No	4123520030				
06.01.2008	R06.01.2008			06.01.2018	R06.01.2018			06.01.2019			R06.01.2025	06.01.2025			
Alternative Part No	4127040080	Alternative Part No	4127040180	Alternative Part No	4127040277	Alternative Part No	4127040190	Alternative Part No	4123520250			Alternative Part No	4123520250		
06.01.2027			06.01.2030			06.01.3052			06.01.3060						
Alternative Part No	4123520307	Alternative Part No	4123520300	Alternative Part No	9115040520	Alternative Part No	9115040600								
R06.01.3104	06.01.3104			06.01.3150			06.01.3506	R06.01.3506			06.01.4000				
Alternative Part No	9115531040	Alternative Part No	9115051500	Alternative Part No	9115051510	Alternative Part No	9115045060	Alternative Part No	9121170000						

EBS NEW & REMANUFACTURED COMPRESSORS - WABCO

06.01.4001		06.01.10000		06.01.10001	
					
Alternative Part No	9125101040	Alternative Part No	9125180050	Alternative Part No	9122100000

EBS NEW COMPRESSORS - MAN

R06.01.4002		06.01.4002		R06.01.4003		06.01.4004		R06.01.4005	
									
Alternative Part No	9125180040	Alternative Part No	9125180030	Alternative Part No	9125120080	Alternative Part No	9125120290	Alternative Part No	9125140040
							9125140040		

06.01.4006		06.01.4012		R06.01.4015		06.01.4029	
							
Alternative Part No	9121160000	Alternative Part No	9125102000	Alternative Part No	9125120150	Alternative Part No	9125120290

06.01.4104	
	
Alternative Part No	9125101040

COMPRESSORS

ALL PISTON RINGS ARE AVAILABLE IN OVERSIZE ORDER RING SETS USING THIS RULE : (e.g. EK--.--.RP.STD = Standard size item.)
 e.g. EK--.--.RP.010= .010 oversize item./e.g. EK--.--.RP.020= .020 oversize item./e.g. EK--.--.RP.030= .030 oversize item./e.g. EK--.--.RP.040= .040 oversize item.

